

Magnetic stop

ISMA 80x50x95

Part no.: 10.01.15.00013

<https://www.schmalz.com/10.01.15.00013>



Homepage > Vacuum Clamping Technology > Clamping Solutions for Woodworking > Modernization of CNC Machining Centers > Accessories and Spare Parts > ISMA 80x50x95

Magnetic stop for clamping system Innospann



Length: 80 mm

Width: 50 mm

Height: 95 mm

Design Data

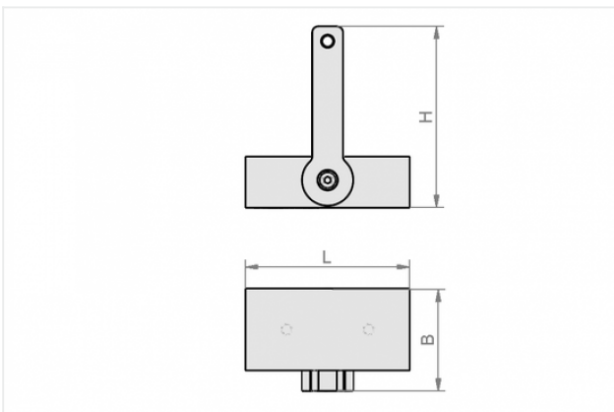

Attribute	Value
-----------	-------

B	50 mm
---	-------

H	95 mm
---	-------

L	80 mm
---	-------

Contact to Schmalz

J. Schmalz GmbH | Johannes-Schmalz-Straße, 72293 Glatten, Deutschland | +49 7443 2403-102 | customercenter@schmalz.de