

Sealing frame

ISDR 81x43x12 Cup 2

<https://www.schmalz.com/10.01.15.00021>



Part no.: 10.01.15.00021

Homepage > Vacuum Clamping Technology > Clamping Solutions for Woodworking > Modernization of CNC Machining Centers > Accessories and Spare Parts > ISDR 81x43x12 Cup 2

Sealing frame



Length L: 81 mm
Width B: 43 mm
Height H: 12 mm
Type: Cup 2

Design Data

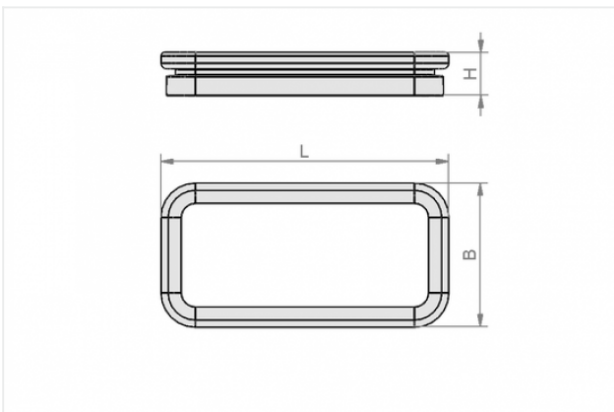

Attribute	Value
-----------	-------

B	43 mm
---	-------

H	12 mm
---	-------

L	81 mm
---	-------

Contact to Schmalz

J. Schmalz GmbH | Johannes-Schmalz-Straße, 72293 Glatten, Deutschland | +49 7443 2403-102 | customercenter@schmalz.de