

Flow resistance

SW 80 G1/4-AG

Part no.: 10.05.04.00014

<https://www.schmalz.com/10.05.04.00014>



Homepage > Vacuum Technology for Automation > Vacuum Components > Valve Technology > Check Valves and Flow Restrictors > Flow Restrictors SW > SW 80 G1/4-AG

Flow resistor for reduction of the volume flow rate



Nominal size: 0.80 mm
Length L: 6 mm
Thread G1: G1/4-M
Material: Aluminium

Design Data

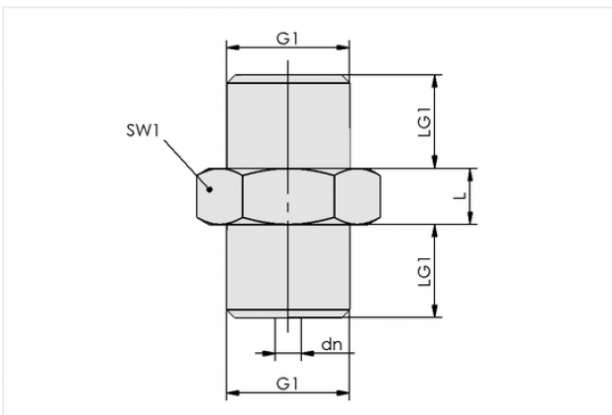

Attribute	Value
G1	G1/4"-M
dn	0.8 mm
L	6 mm
LG1	10 mm
SW1	17 mm

Technical Data

Attribute	Value
Nominal size	0.80 mm
Evacuation rate for $p_u = -0,3$ bar	0.3 m ³ /h

Contact to Schmalz

J. Schmalz GmbH | Johannes-Schmalz-Straße, 72293 Glatten, Deutschland | +49 7443 2403-102 | customercenter@schmalz.de

Attribute	Value
Evacuation rate for pu = -0,3 bar	4.9 l/min
Evacuation rate for pu = -0,6 bar	0.32 m ³ /h
Evacuation rate for pu = -0,6 bar	5.3 l/min
Weight	9.4 g
