

Schmalz Pad Insert

SPI 21 PEEK

<https://www.schmalz.com/10.01.06.03285>



Part no.: 10.01.06.03285

Homepage > Vacuum Technology for Automation > Vacuum Components > Vacuum Suction Cups > Accessories Vacuum Suction Cups > Suction Cup Inserts SPI PEEK > SPI 21 PEEK

Insert disc for preventing film from being drawn in



Size: 21
Material: Polyetheretherketon
Application: FG20/FGA22

Design Data

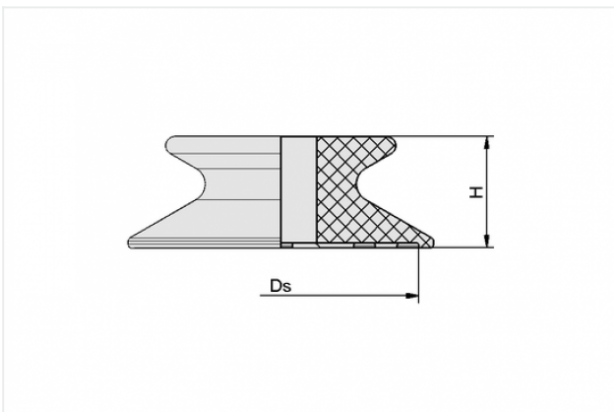

Attribute	Value
Ds	19 mm
H	6.3 mm

Technical Data

Attribute	Value
Application	FG20/FGA22
Material	Polyetheretherketon

Contact to Schmalz

J. Schmalz GmbH | Johannes-Schmalz-Straße, 72293 Glatten, Deutschland | +49 7443 2403-102 | customercenter@schmalz.de

Attribute	Value
Weight	1.3 g

Note:

- Suction capacity of min. 2 l/min is recommended. An experiment has to be carried out with the original workpiece and suction pads to define the required suction power for the application. Frictional force is reduced during vertical applications.
-
-