

Bellows suction cup HT1 (round)

<https://www.schmalz.com/10.01.06.03066>



SAB 125 HT1-60 G3/8-AG

Part no.: 10.01.06.03066

Homepage > Vacuum Technology for Automation > Vacuum Components > Vacuum Suction Cups > Suction Cups for Handling Glass > Bellows

Suction Cups SAB HT1 (1.5 Folds) > SAB 125 HT1-60 G3/8-AG

Bellows suction cup (round) for markless handling of workpieces



Size: 125
Suction cup material:
High temp material HT1
Material hardness: 60 °Sh
Vacuum connection: G3/8-M
Number of folds: 1.5
Nipple material: Aluminium

Design Data

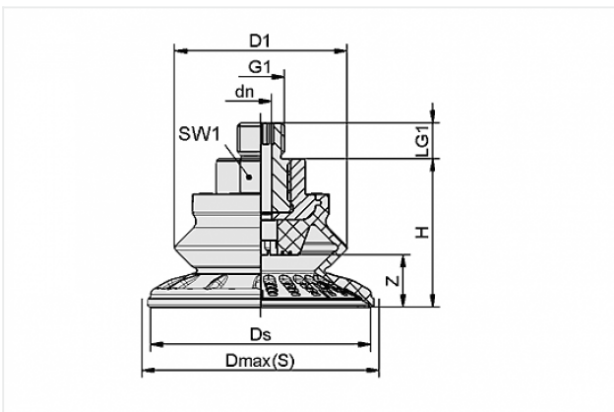

Attribute	Value
-----------	-------

dn	6 mm
D1	94 mm
Dmax(S)	135 mm
Ds	126 mm
G1	G3/8"-M
H	67.8 mm
LG1	10 mm
SW1	22 mm
Z	32 mm

Contact to Schmalz

J. Schmalz GmbH | Johannes-Schmalz-Straße, 72293 Glatten, Deutschland | +49 7443 2403-102 | customercenter@schmalz.de

Technical Data

Attribute	Value
Suction force	250 N
Pull-off force	558 N
Lateral force	352 N
Lateral force (oily surface)	335 N
Volume	191 cm ³
Curve radius (min) (convex)	140 mm
Internal hose diameter (recom.)	9 mm
Size	125
Number of folds	1.5
Suction cup material	High temp material HT1
Material hardness	60 °Sh
Weight	177.3 g
Product family	SAB