

Bellows suction cup HT1 (round)

<https://www.schmalz.com/10.01.06.02728>



SAB 100 HT1-60 G3/8-IG

Part no.: 10.01.06.02728

Homepage > Vacuum Technology for Automation > Vacuum Components > Vacuum Suction Cups > Suction Cups for Handling Glass > Bellows

Suction Cups SAB HT1 (1.5 Folds) > SAB 100 HT1-60 G3/8-IG

Bellows suction cup (round) for markless handling of workpieces



Size: 100
Suction cup material:
High temp material HT1
Material hardness: 60 °Sh
Vacuum connection: G3/8-F
Number of folds: 1.5
Nipple material: Aluminium

Design Data

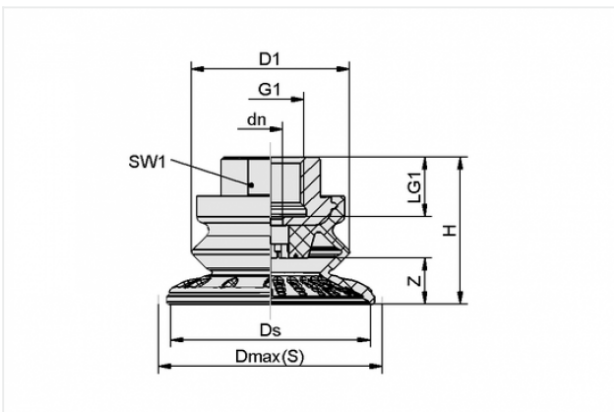

Attribute	Value
-----------	-------

dn	6 mm
D1	77 mm
Dmax(S)	110 mm
Ds	100.8 mm
G1	G3/8"-F
H	56.6 mm
LG1	15 mm
SW1	22 mm
Z	25.8 mm

Contact to Schmalz

J. Schmalz GmbH | Johannes-Schmalz-Straße, 72293 Glatten, Deutschland | +49 7443 2403-102 | customercenter@schmalz.de

Technical Data

Attribute	Value
Suction force	190 N
Pull-off force	357 N
Lateral force	220 N
Lateral force (oily surface)	214 N
Volume	92.5 cm ³
Curve radius (min) (convex)	90 mm
Internal hose diameter (recom.)	6 mm
Size	100
Number of folds	1.5
Suction cup material	High temp material HT1
Material hardness	60 °Sh
Weight	88.2 g
Product family	SAB