

Bellows suction cup HT1 (round)

<https://www.schmalz.com/10.01.06.02725>



SAB 50 HT1-60 G3/8-IG

Part no.: 10.01.06.02725

Homepage > Vacuum Technology for Automation > Vacuum Components > Vacuum Suction Cups > Suction Cups for Handling Glass > Bellows

Suction Cups SAB HT1 (1.5 Folds) > SAB 50 HT1-60 G3/8-IG

Bellows suction cup (round) for markless handling of workpieces



Size: 50
Suction cup material:
High temp material HT1
Material hardness: 60 °Sh
Vacuum connection: G3/8-F
Number of folds: 1.5
Nipple material: Aluminium

Design Data

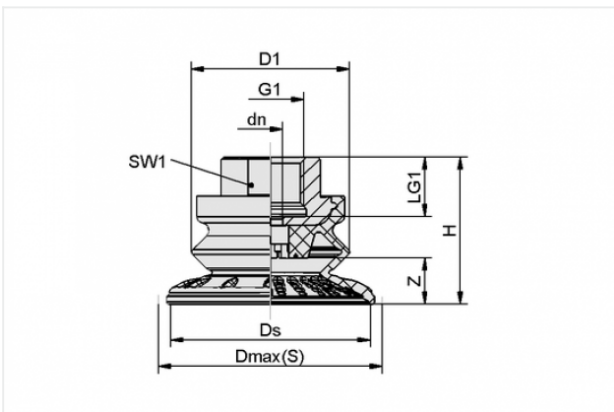

Attribute	Value
-----------	-------

dn	6 mm
D1	39.5 mm
Dmax(S)	56 mm
Ds	50.1 mm
G1	G3/8"-F
H	36.9 mm
LG1	15 mm
SW1	22 mm
Z	11.5 mm

Contact to Schmalz

J. Schmalz GmbH | Johannes-Schmalz-Straße, 72293 Glatten, Deutschland | +49 7443 2403-102 | customercenter@schmalz.de

Technical Data

Attribute	Value
Suction force	53 N
Pull-off force	87 N
Lateral force	55 N
Lateral force (oily surface)	52 N
Volume	11.5 cm ³
Curve radius (min) (convex)	50 mm
Internal hose diameter (recom.)	4 mm
Size	50
Number of folds	1.5
Suction cup material	High temp material HT1
Material hardness	60 °Sh
Weight	32.3 g
Product family	SAB
