

Bellows suction cup HT1 (round)

<https://www.schmalz.com/10.01.06.03049>



SAB 30 HT1-60 G3/8-AG

Part no.: 10.01.06.03049

Homepage > Vacuum Technology for Automation > Vacuum Components > Vacuum Suction Cups > Suction Cups for Handling Glass > Bellows

Suction Cups SAB HT1 (1.5 Folds) > SAB 30 HT1-60 G3/8-AG

Bellows suction cup (round) for markless handling of workpieces



Size: 30
Suction cup material:
High temp material HT1
Material hardness: 60 °Sh
Vacuum connection: G3/8-M
Number of folds: 1.5
Nipple material: Aluminium

Design Data

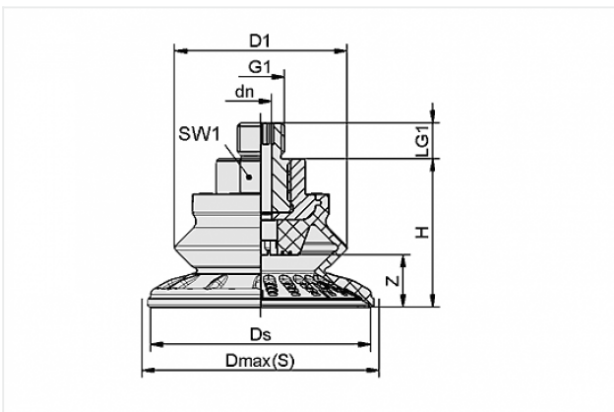

Attribute	Value
-----------	-------

dn	4 mm
D1	32 mm
Dmax(S)	34 mm
Ds	30.6 mm
G1	G3/8"-M
H	28 mm
LG1	10 mm
SW1	17 mm
Z	9 mm

Contact to Schmalz

J. Schmalz GmbH | Johannes-Schmalz-Straße, 72293 Glatten, Deutschland | +49 7443 2403-102 | customercenter@schmalz.de

Technical Data

Attribute	Value
Suction force	22 N
Pull-off force	33 N
Lateral force	30 N
Lateral force (oily surface)	13 N
Volume	5.9 cm ³
Curve radius (min) (convex)	40 mm
Internal hose diameter (recom.)	4 mm
Size	30
Number of folds	1.5
Suction cup material	High temp material HT1
Material hardness	60 °Sh
Weight	20.8 g
Product family	SAB