

Bellows suction cup (round)

<https://www.schmalz.com/10.01.06.01055>



SAB 50 NBR-60 RA

Part no.: 10.01.06.01055

Homepage > Vacuum Technology for Automation > Vacuum Components > Vacuum Suction Cups > Suction Cups for Handling Sheet Metal >

Bellows Suction Cups SAB (1.5 Folds) > SAB 50 NBR-60 RA

Bellows suction cup (round) for very dynamic handling of smooth and oily workpieces



Size: 50

Suction cup material:

Nitrile rubber NBR

Material hardness: 60 °Sh

Vacuum connection:

Rectangular adapter

Nipple material: Aluminium

Number of folds: 1.5

Design Data

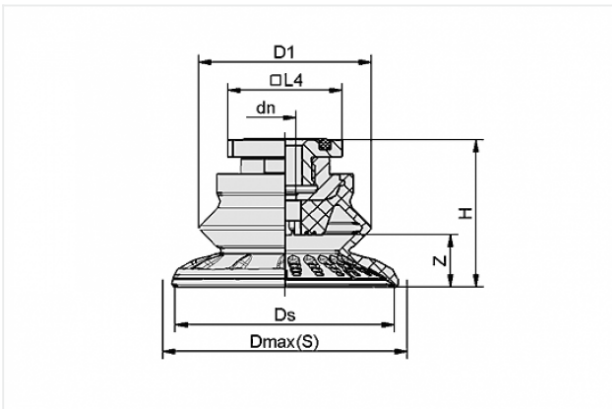

Attribute	Value
-----------	-------

dn	6 mm
----	------

D1	39.5 mm
----	---------

Dmax(S)	56 mm
---------	-------

Ds	50.1 mm
----	---------

H	36.6 mm
---	---------

L4	31.8 mm
----	---------

Z	11.5 mm
---	---------

Technical Data

Contact to Schmalz

J. Schmalz GmbH | Johannes-Schmalz-Straße, 72293 Glatten, Deutschland | +49 7443 2403-102 | customercenter@schmalz.de

Attribute	Value
Suction force	53 N
Pull-off force	87 N
Lateral force	55 N
Lateral force (oily surface)	52 N
Volume	16.1 cm ³
Curve radius (min) (convex)	50 mm
Internal hose diameter (recom.)	4 mm
Size	50
Suction cup material	Nitrile rubber NBR
Material hardness	60 °Sh
Weight	41.5 g
Number of folds	1.5
Product family	SAB

Note:

- Suction force: The specified suction forces are theoretical values at a vacuum of -0.6 bar and with a smooth, dry workpiece surface - they do not include a safety factor
- Lateral force: The specified lateral forces are values measured at a vacuum of -0.6 bar with a dry or oily, smooth, flat workpiece surface. Depending on the workpiece surface and its quality, the actual values may deviate from these values
- Hose diameter: The recommended hose diameter refers to a hose length of approx. 2 m