

Bellows suction cup (round)

<https://www.schmalz.com/10.01.06.00996>



SAB 50 NBR-60 M10-AG

Part no.: 10.01.06.00996

Homepage > Vacuum Technology for Automation > Vacuum Components > Vacuum Suction Cups > Suction Cups for Handling Sheet Metal >

Bellows Suction Cups SAB (1.5 Folds) > SAB 50 NBR-60 M10-AG

Bellows suction cup (round) for very dynamic handling of smooth and oily workpieces



Size: 50
Suction cup material:
Nitrile rubber NBR
Material hardness: 60 °Sh
Vacuum connection: M10-M
Nipple material: Steel
Number of folds: 1.5

Design Data

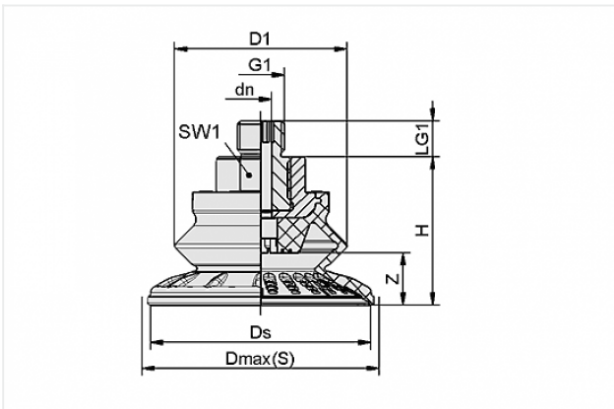

Attribute	Value
-----------	-------

dn	4 mm
D1	39.5 mm
Dmax(S)	56 mm
Ds	50.1 mm
G1	M10-M
H	36.9 mm
LG1	12 mm
SW1	22 mm
Z	11.5 mm

Contact to Schmalz

J. Schmalz GmbH | Johannes-Schmalz-Straße, 72293 Glatten, Deutschland | +49 7443 2403-102 | customercenter@schmalz.de

Technical Data

Attribute	Value
Suction force	53 N
Pull-off force	87 N
Lateral force	55 N
Lateral force (oily surface)	52 N
Volume	16.1 cm ³
Curve radius (min) (convex)	50 mm
Internal hose diameter (recom.)	4 mm
Size	50
Suction cup material	Nitrile rubber NBR
Material hardness	60 °Sh
Weight	55.7 g
Number of folds	1.5
Product family	SAB

Note:

- Suction force: The specified suction forces are theoretical values at a vacuum of -0.6 bar and with a smooth, dry workpiece surface - they do not include a safety factor
- Lateral force: The specified lateral forces are values measured at a vacuum of -0.6 bar with a dry or oily, smooth, flat workpiece surface. Depending on the workpiece surface and its quality, the actual values may deviate from these values
- Hose diameter: The recommended hose diameter refers to a hose length of approx. 2 m