

Flat suction cup (oval)

<https://www.schmalz.com/10.01.05.00580>



SAOF 80x40 NBR-45 RA

Part no.: 10.01.05.00580

Homepage > Vacuum Technology for Automation > Vacuum Components > Vacuum Suction Cups > Flat Suction Cups (Oval) > Flat Suction Cups
SAOF (Oval) > SAOF 80x40 NBR-45 RA

Flat suction cup (oval) for very dynamic handling of smooth and oily workpieces



Dimensions (LxB): 80 x 40 mm

Suction cup material:

Nitrile rubber NBR

Material hardness: 45 °Sh

Nipple material: Aluminium

Vacuum connection:

Rectangular adapter

Design Data

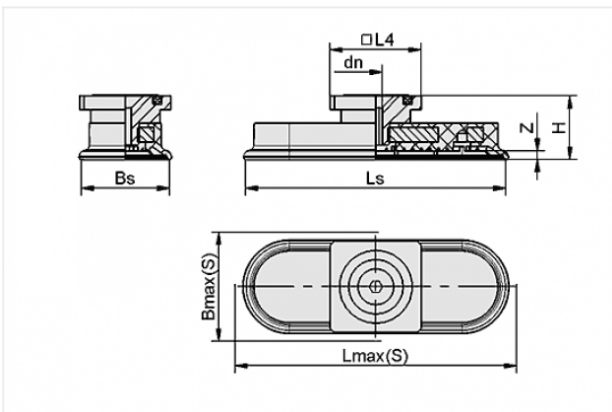

Attribute	Value
-----------	-------

Bmax(S)	43 mm
---------	-------

Bs	38.6 mm
----	---------

dn	4 mm
----	------

H	23 mm
---	-------

L4	32 mm
----	-------

Lmax(S)	85 mm
---------	-------

Ls	80.6 mm
----	---------

Z	4 mm
---	------

Technical Data

Contact to Schmalz

J. Schmalz GmbH | Johannes-Schmalz-Straße, 72293 Glatten, Deutschland | +49 7443 2403-102 | customercenter@schmalz.de

Attribute	Value
Suction force	140 N
Lateral force	110 N
Lateral force (oily surface)	100 N
Volume	11.7 cm ³
Curve radius (min) (convex)	50 mm
Internal hose diameter (recom.)	4 mm
Dimensions (LxB)	80 x 40 mm
Number of folds	0
Suction cup material	Nitrile rubber NBR
Material hardness	45 °Sh
Weight	44 g
Product family	SAOF

Note:

- Suction force: The specified suction forces are theoretical values at a vacuum of -0.6 bar and with a smooth, dry workpiece surface - they do not include a safety factor
- Lateral force: The specified lateral forces are values measured at a vacuum of -0.6 bar with a dry or oily, smooth, flat workpiece surface. Depending on the workpiece surface and its quality, the actual values may deviate from these values
- Hose diameter: The recommended hose diameter refers to a hose length of approx. 2 m