

Flat suction cup (oval)

SAOF 80x40 NBR-60 M10-AG

<https://www.schmalz.com/10.01.05.00329>



Part no.: 10.01.05.00329

Homepage > Vacuum Technology for Automation > Vacuum Components > Vacuum Suction Cups > Flat Suction Cups (Oval) > Flat Suction Cups SAOF (Oval) > SAOF 80x40 NBR-60 M10-AG

Flat suction cup (oval) for very dynamic handling of smooth and oily workpieces



Dimensions (LxB): 80 x 40 mm
 Suction cup material:
 Nitrile rubber NBR
 Material hardness: 60 °Sh
 Nipple material: Steel
 Vacuum connection: M10-M

Design Data

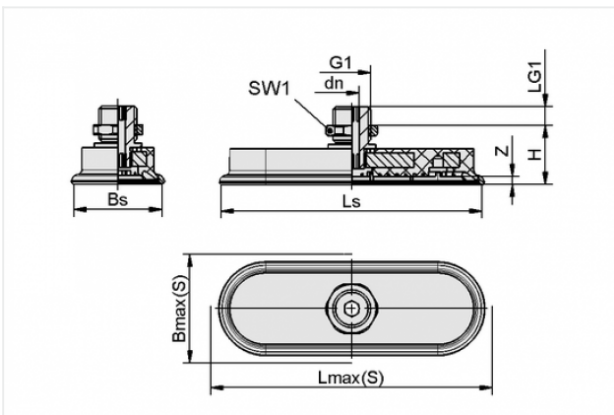

Attribute	Value
Bmax(S)	43 mm
Bs	38.6 mm
dn	4 mm
G1	M10-M
H	20 mm
LG1	10 mm
Lmax(S)	85 mm
Ls	80.6 mm
SW1	17 mm
Z	4 mm

Contact to Schmalz

J. Schmalz GmbH | Johannes-Schmalz-Straße, 72293 Glatten, Deutschland | +49 7443 2403-102 | customercenter@schmalz.de

Technical Data

Attribute	Value
Suction force	140 N
Lateral force	110 N
Lateral force (oily surface)	100 N
Volume	11.7 cm ³
Curve radius (min) (convex)	50 mm
Internal hose diameter (recom.)	4 mm
Dimensions (LxB)	80 x 40 mm
Number of folds	0
Suction cup material	Nitrile rubber NBR
Material hardness	60 °Sh
Weight	47 g
Product family	SAOF

Note:

- Suction force: The specified suction forces are theoretical values at a vacuum of -0.6 bar and with a smooth, dry workpiece surface - they do not include a safety factor
 - Lateral force: The specified lateral forces are values measured at a vacuum of -0.6 bar with a dry or oily, smooth, flat workpiece surface. Depending on the workpiece surface and its quality, the actual values may deviate from these values
 - Hose diameter: The recommended hose diameter refers to a hose length of approx. 2 m
-
-