

# Flat suction cup (round)

<https://www.schmalz.com/10.01.01.11464>



## SAF 80 NBR-45 RA

Part no.: 10.01.01.11464

Homepage > Vacuum Technology for Automation > Vacuum Components > Vacuum Suction Cups > Flat Suction Cups (Round) > Flat Suction Cups

SAF > SAF 80 NBR-45 RA

## Flat suction cup (round) for very dynamic handling of smooth and oily workpieces



Size: 80  
Suction cup material:  
Nitrile rubber NBR  
Material hardness: 45 °Sh  
Vacuum connection:  
Rectangular adapter  
Nipple material: Aluminium

### Design Data

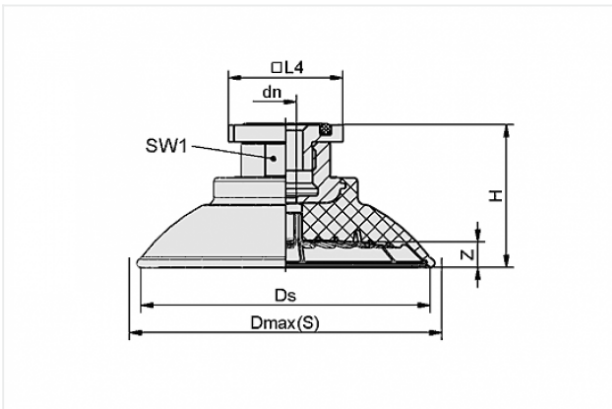

Attribute	Value
dn	6 mm
Dmax(S)	89 mm
Ds	83 mm
H	34.5 mm
SW1	22 mm
Z	7.6 mm

### Technical Data

Attribute	Value
Suction force	272 N

### Contact to Schmalz

J. Schmalz GmbH | Johannes-Schmalz-Straße, 72293 Glatten, Deutschland | +49 7443 2403-102 | [customercenter@schmalz.de](mailto:customercenter@schmalz.de)

Attribute	Value
Lateral force	205 N
Lateral force (oily surface)	180 N
Volume	36.7 cm <sup>3</sup>
Curve radius (min) (convex)	100 mm
Internal hose diameter (recom.)	6 mm
Size	80
Suction cup material	Nitrile rubber NBR
Material hardness	45 °Sh
Weight	65.2 g
Number of folds	0
Product family	SAF

**Note:**

- Suction force: The specified suction forces are theoretical values at a vacuum of -0.6 bar and with a smooth, dry workpiece surface - they do not include a safety factor
- Lateral force: The specified lateral forces are values measured at a vacuum of -0.6 bar with a dry or oily, smooth, flat workpiece surface. Depending on the workpiece surface and its quality, the actual values may deviate from these values
- Hose diameter: The recommended hose diameter refers to a hose length of approx. 2 m

**Accessories**



**SU 80**

Part no. 10.01.01.12839

Cover for suction cup

Size: 80

Clamping range: 80.0 ... 100.0 mm

Temperature resistance: 80 °C

