

Flat suction cup (round)

<https://www.schmalz.com/10.01.01.10690>



SAF 80 NBR-60 G1/4-IG

Part no.: 10.01.01.10690

Homepage > Vacuum Technology for Automation > Vacuum Components > Vacuum Suction Cups > Suction Cups for Handling Sheet Metal > Flat Suction Cups SAF > SAF 80 NBR-60 G1/4-IG

Flat suction cup (round) for very dynamic handling of smooth and oily workpieces



Size: 80
Suction cup material:
Nitrile rubber NBR
Material hardness: 60 °Sh
Vacuum connection: G1/4-F
Nipple material: Brass, nickel-plated

Design Data

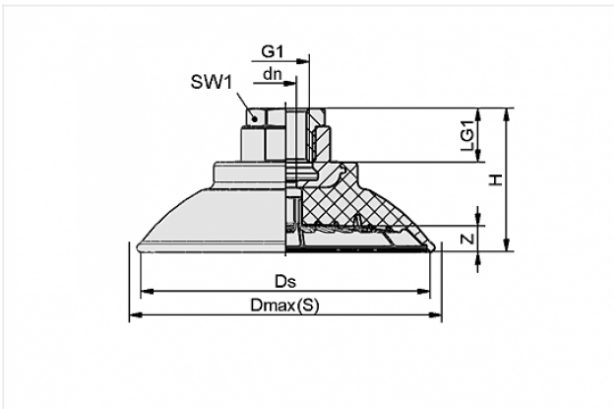

Attribute	Value
dn	6 mm
Dmax(S)	89 mm
Ds	83 mm
G1	G1/4"-F
H	40 mm
LG1	20 mm
SW1	22 mm
Z	7.6 mm

Technical Data

Contact to Schmalz

J. Schmalz GmbH | Johannes-Schmalz-Straße, 72293 Glatten, Deutschland | +49 7443 2403-102 | customercenter@schmalz.de

Attribute	Value
Suction force	272 N
Lateral force	205 N
Lateral force (oily surface)	180 N
Volume	36.7 cm ³
Curve radius (min) (convex)	100 mm
Internal hose diameter (recom.)	6 mm
Size	80
Suction cup material	Nitrile rubber NBR
Material hardness	60 °Sh
Weight	56.2 g
Number of folds	0
Product family	SAF

Note:

- Suction force: The specified suction forces are theoretical values at a vacuum of -0.6 bar and with a smooth, dry workpiece surface - they do not include a safety factor
- Lateral force: The specified lateral forces are values measured at a vacuum of -0.6 bar with a dry or oily, smooth, flat workpiece surface. Depending on the workpiece surface and its quality, the actual values may deviate from these values
- Hose diameter: The recommended hose diameter refers to a hose length of approx. 2 m

Accessories



SU 80

Part no. 10.01.01.12839

Cover for suction cup

Size: 80

Clamping range: 80.0 ... 100.0 mm

Temperature resistance: 80 °C

Contact to Schmalz

