

# Flat suction cup (round)

<https://www.schmalz.com/10.01.01.10622>



## SAF 60 NBR-60 G1/4-AG

Part no.: 10.01.01.10622

Homepage > Vacuum Technology for Automation > Vacuum Components > Vacuum Suction Cups > Suction Cups for Handling Sheet Metal > Flat Suction Cups SAF > SAF 60 NBR-60 G1/4-AG

## Flat suction cup (round) for very dynamic handling of smooth and oily workpieces



Size: 60  
Suction cup material:  
Nitrile rubber NBR  
Material hardness: 60 °Sh  
Vacuum connection: G1/4-M  
Nipple material: Aluminium

### Design Data

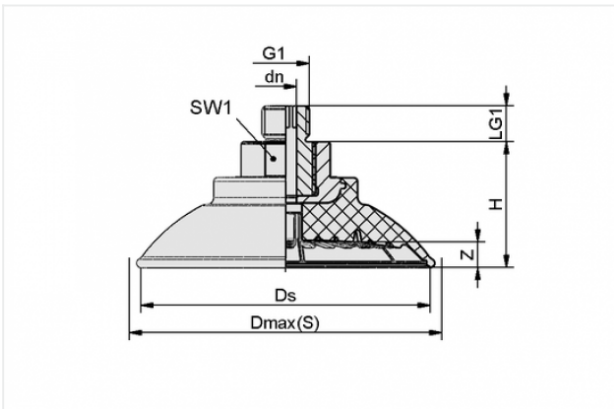

Attribute	Value
-----------	-------

dn	6 mm
Dmax(S)	67 mm
Ds	60.6 mm
G1	G1/4"-M
H	31 mm
LG1	10 mm
SW1	22 mm
Z	6 mm

### Technical Data

#### Contact to Schmalz

J. Schmalz GmbH | Johannes-Schmalz-Straße, 72293 Glatten, Deutschland | +49 7443 2403-102 | [customercenter@schmalz.de](mailto:customercenter@schmalz.de)

Attribute	Value
Suction force	150 N
Lateral force	105 N
Lateral force (oily surface)	85 N
Volume	16.7 cm <sup>3</sup>
Curve radius (min) (convex)	75 mm
Internal hose diameter (recom.)	6 mm
Size	60
Suction cup material	Nitrile rubber NBR
Material hardness	60 °Sh
Weight	46.4 g
Number of folds	0
Product family	SAF

**Note:**

- Suction force: The specified suction forces are theoretical values at a vacuum of -0.6 bar and with a smooth, dry workpiece surface - they do not include a safety factor
- Lateral force: The specified lateral forces are values measured at a vacuum of -0.6 bar with a dry or oily, smooth, flat workpiece surface. Depending on the workpiece surface and its quality, the actual values may deviate from these values
- Hose diameter: The recommended hose diameter refers to a hose length of approx. 2 m

**Accessories**



**SU 60**

Part no. 10.01.01.13585

Cover for suction cup

Size: 60

Temperature resistance: 80 °C

