

## Flat suction cup (round)

### SUF 4 NBR-ESD-55 M3-AG

Part no.:10.01.01.14213

<https://www.schmalz.com/10.01.01.14213>

Homepage > Vacuum Technology for Automation > Vacuum Components > Vacuum Suction Cups > Flat suction cup (round) > Flat Suction

Cups SUF > SUF 4 NBR-ESD-55 M3-AG

## Flat suction cup (round) for process safe handling of smooth or slightly rough surfaces

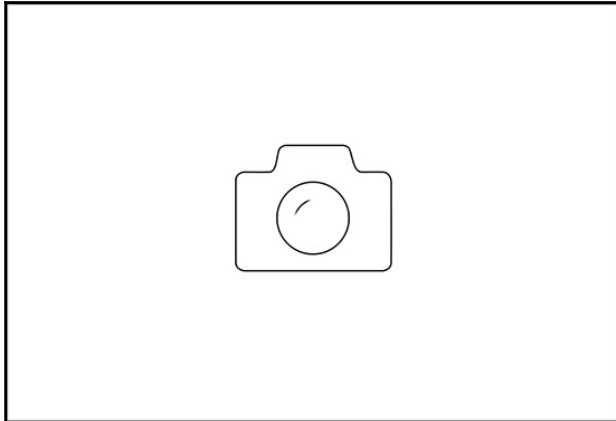

Size: 4

Suction cup material:

Nitrile rubber NBR-dissipative

Material hardness: 55 °Sh

### Design Data

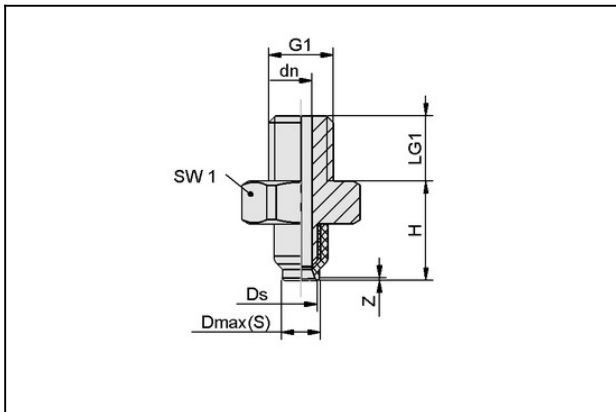

Attribute	Value
Dmax(S)	4.7 mm
Ds	4 mm
dn	1 mm
G1	M3-M
H	5.5 mm
LG1	3 mm
SW1	5 mm
Z (Stroke)	0.4 mm

### Technical Data

#### Contact to Schmalz

J. Schmalz GmbH | Johannes-Schmalz-Straße, 72293 Glatten, Deutschland | +49 7443 2403-102 | [customercenter@schmalz.de](mailto:customercenter@schmalz.de)

## Flat suction cup (round)

### SUF 4 NBR-ESD-55 M3-AG

Part no.:10.01.01.14213

<https://www.schmalz.com/10.01.01.14213>

Attribute	Value
Size	4
Suction cup material	Nitrile rubber NBR-dissipative
Material hardness [Shore A]	55.0 Shore A

---

### Spare Parts



#### SC 010 M3-AG

Part no.10.01.06.04249

Connection element for suction cup "SchmalzConnector"

Connection geometry: 010

Vacuum connection: M3-M

Fitting length: 2 mm

Nominal diameter dn: 1 mm