

SOFT-CLOSE DAMPENING HINGE



HG-JHM16



- Hinge with damper built-in to keep lid from slamming shut.
- Mortise mount type.
- Ideal for small size lid.
- Sold in pairs.
- Torque Calculation:
Torque = Door Height x 1/2 x Door Weight
- *Please see diagram below for applicable torque moment.
- *Please specify face plate color (sold separately) when ordering.
- *Please install Left and Right brackets on correct side.

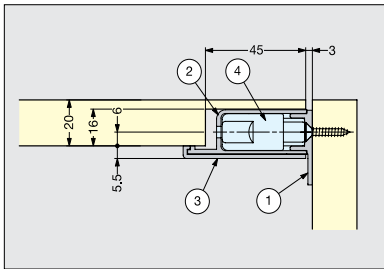
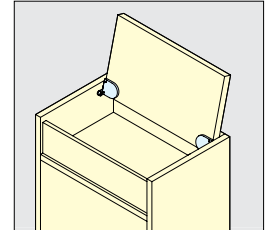

Installation

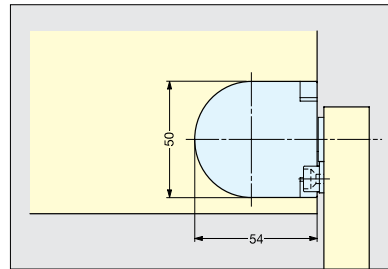

Installation (90° open position)

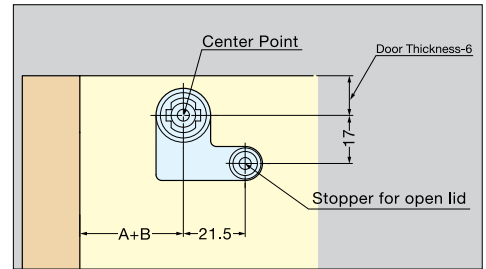

Mounting Plate Installation

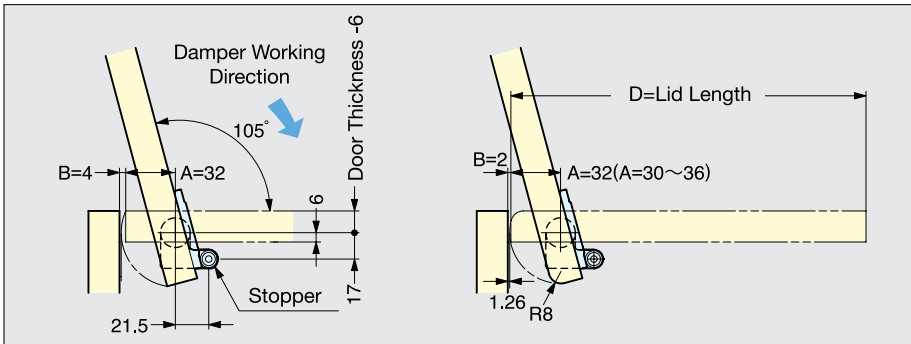

Standard Installation

Installation with Rounded Lid Edge.

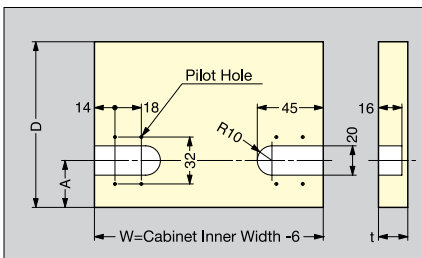

Bore Dimensions

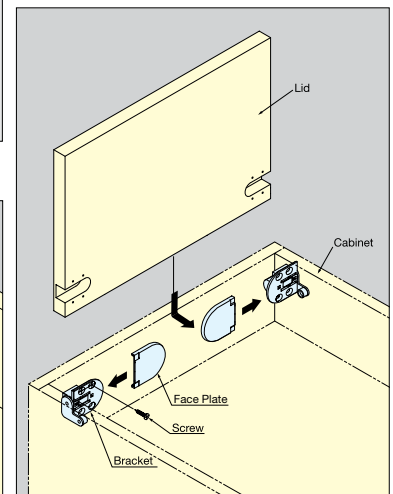
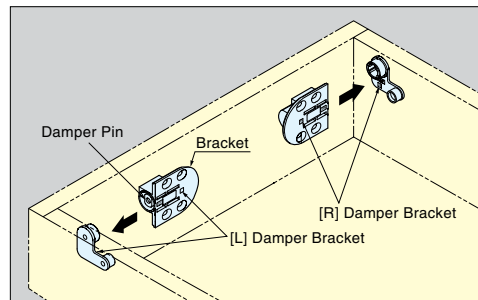

Item No.	Part Name	Color	Torque per pair (kgf-cm)	Weight (g)	Box	Carton
HG-JHM16-34	Body	Black	20~34 (17.4~29.5 lbs-in)	91/pair	10 pairs	120 pairs
HG-JHM16-50			34~50 (29.5~43.4 lbs-in)			
HG-JHM16-BL	Face Plate	Black	-	12/pair	10 pairs	120 pairs
HG-JHM16-WT		White				

No.	Part Name	Material	Color
①	Mounting Plate	Aluminum	Black
②	Damper Bracket	Polyacetal	
③	Face Plate	ABS	White/Black
④	Damper	304 Stainless Steel	Plain