

Flat suction cup (round)

SUF 70 HT1-60 G1/4-AG

Part no.:10.01.01.14078

<https://www.schmalz.com/10.01.01.14078>

Homepage > Vacuum Technology for Automation > Vacuum Components > Vacuum Suction Cups > Flat suction cup (round) > Suction Cups

SUF > SUF 70 HT1-60 G1/4-AG

Flat suction cup (round) for process safe handling of smooth or slightly rough surfaces

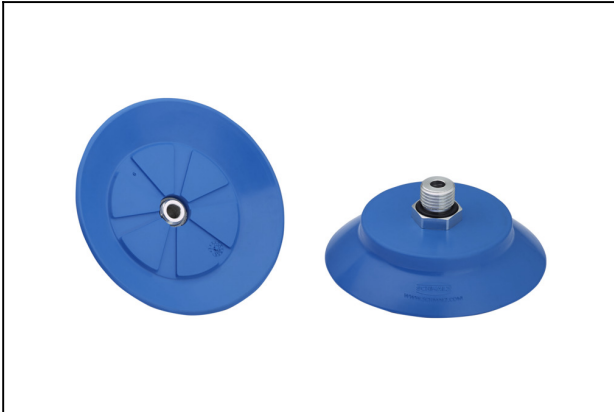

Size: 70

Suction cup material:

High temp material HT1

Material hardness: 60 °Sh

Design Data

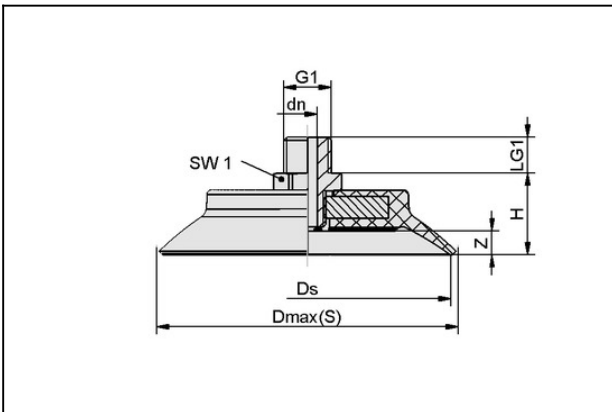

Attribute	Value
Dmax(S)	77.2 mm
Ds	70 mm
dn	5.1 mm
G1	G1/4"-M
H	22.5 mm
LG1	10 mm
SW1	17 mm
Z (Stroke)	6 mm

Technical Data

Contact to Schmalz

J. Schmalz GmbH | Johannes-Schmalz-Straße, 72293 Glatten, Deutschland | +49 7443 2403-102 | customercenter@schmalz.de



Flat suction cup (round)

SUF 70 HT1-60 G1/4-AG

Part no.:10.01.01.14078

<https://www.schmalz.com/10.01.01.14078>

Attribute	Value
Size	70
Suction cup material	High temp material HT1
Material hardness [Shore A]	60 Shore A
Abreißkraft (real)	197.8 N
