

## Flat suction cup (round)

### SUF 8 SI-AS-55 M5-AG

Part no.:10.01.01.14244

<https://www.schmalz.com/10.01.01.14244>

Homepage > Vacuum Technology for Automation > Vacuum Components > Vacuum Suction Cups > Flat suction cup (round) > Suction Cups

SUF > SUF 8 SI-AS-55 M5-AG

## Flat suction cup (round) for process safe handling of smooth or slightly rough surfaces



Size: 8

Suction cup material:

Silicone SI-antistatic

Material hardness: 55 °Sh

### Design Data

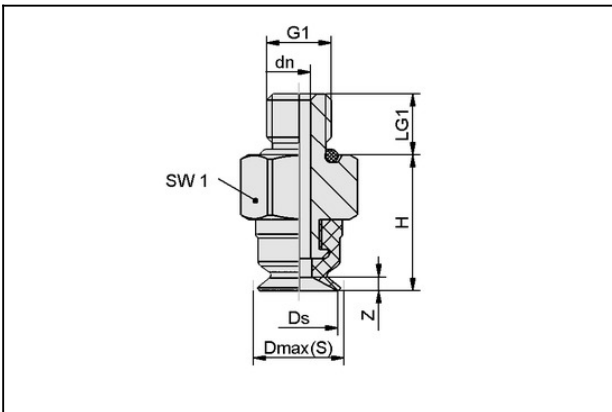

Attribute	Value
Dmax(S)	8.4 mm
Ds	8 mm
dn	1.8 mm
G1	M5-M
H	10.5 mm
LG1	4.7 mm
SW1	8 mm
Z (Stroke)	0.8 mm

### Technical Data

#### Contact to Schmalz

J. Schmalz GmbH | Johannes-Schmalz-Straße, 72293 Glatten, Deutschland | +49 7443 2403-102 | [customercenter@schmalz.de](mailto:customercenter@schmalz.de)

## Flat suction cup (round)

### SUF 8 SI-AS-55 M5-AG

Part no.:10.01.01.14244

<https://www.schmalz.com/10.01.01.14244>

Attribute	Value
Size	8
Suction cup material	Silicone SI-antistatic
Material hardness [Shore A]	55 Shore A
Abreißkraft (real)	2.4 N

## Spare Parts

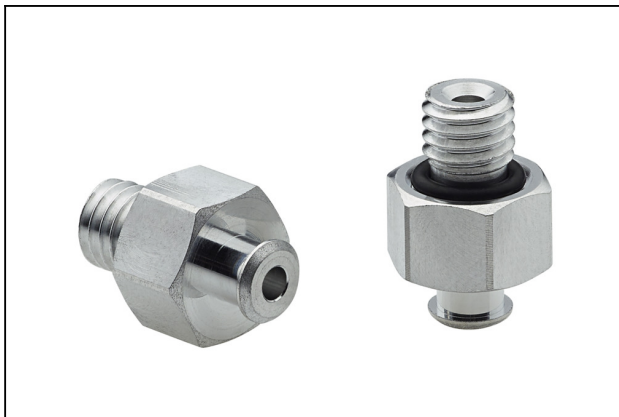

### SC 020 M5-AG

Part no.10.01.06.04273

Connection element for suction cup "SchmalzConnector"

Connection geometry: 020

Vacuum connection: M5-M

Overall length: 12.7 mm

Fitting length: 5 mm

Nominal diameter dn: 1.8 mm



### SUF 8 SI-AS-55 SC020

Part no.10.01.01.14027

Flat suction cup (round) f. process- safe handling of smooth or slightly rough surfaces

Size: 8

Suction cup material:

Silicone SI-antistatic

Material hardness: 55 °Sh