

Flat suction cup (round)

SUF 2 SI-55 M3-AG

Part no.:10.01.01.14204

<https://www.schmalz.com/10.01.01.14204>

Homepage > Vacuum Technology for Automation > Vacuum Components > Vacuum Suction Cups > Flat suction cup (round) > Suction Cups

SUF > SUF 2 SI-55 M3-AG

Flat suction cup (round) for process safe handling of smooth or slightly rough surfaces



Size: 2

Suction cup material: Silicone SI

Material hardness: 55 °Sh

Design Data

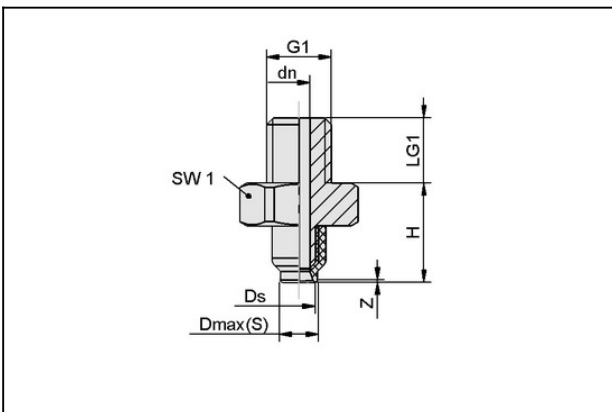

Attribute	Value
Dmax(S)	2.4 mm
Ds	2 mm
dn	1 mm
G1	M3-M
H	5.5 mm
LG1	3 mm
SW1	5 mm
Z (Stroke)	0.2 mm

Technical Data

Contact to Schmalz

J. Schmalz GmbH | Johannes-Schmalz-Straße, 72293 Glatten, Deutschland | +49 7443 2403-102 | customercenter@schmalz.de

Flat suction cup (round)

SUF 2 SI-55 M3-AG

Part no.:10.01.01.14204

<https://www.schmalz.com/10.01.01.14204>

Attribute	Value
Size	2
Suction cup material	Silicone SI
Material hardness [Shore A]	55 Shore A

Spare Parts



SC 010 M3-AG

Part no.10.01.06.04249

Connection element for suction cup "SchmalzConnector"

Connection geometry: 010

Vacuum connection: M3-M

Fitting length: 2 mm

Nominal diameter dn: 1 mm

<>



SUF 2 SI-55 SC010

Part no.10.01.01.13960

Flat suction cup (round) f. process- safe handling of smooth or slightly rough surfaces

Size: 2

Suction cup material: Silicone SI

Material hardness: 55 °Sh