



# LIFT-ASSIST HINGE HG-PA SERIES



- Easy to lift heavy top-opening lid with spring tension (lift assist function).
- Smooth and soft-closing movement at the end, preventing lid from slamming shut.
- Torque is adjustable by turning the adjustment screw (see below).

**[Specifications]**

- Operating temperature: 0°C ~40°C

**[Applications]**

- Medical equipment, analytical instruments, semiconductor equipment etc.

**[Remarks]**

- Be sure to read the "Cautions" 1.
- When installing, ensure that both hinge shafts are levelled and aligned.
- Install a stopper (not included) on the cabinet to prevent from exceeding the operating angle during opening or closing.
- Do not use outdoors.
- Check if the cabinet has sufficient strength and rigidity before use.
- For inside mount type, check the torque adjusting screw position, and turn the screw with cabinet and lid already mounted.

**Video Link**



Video Design Tec  
**Video Lift Assist**



**S**election Tool  
**Sasuga-kun**  
Applicable Products  
Used for Product Selection & Simulation.  
Available on Web!

**Lift assist function**

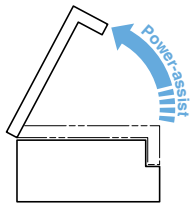

**Soft-close function**

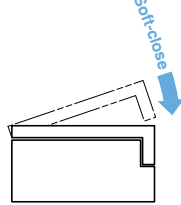



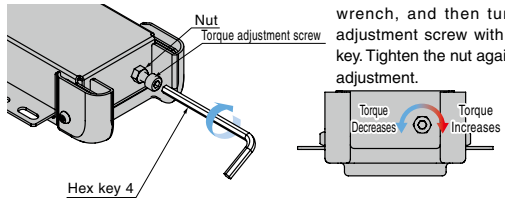

**[How to Adjust Torque]**

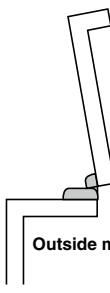

Loose the end nut with a wrench, and then turn the adjustment screw with a hex key. Tighten the nut again after adjustment.

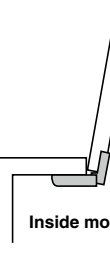
**[HG-PA Series]**

Type	Torque N · m	Torque kgf · cm	Torque Adjustment Range	Item Name	Page
 <b>Outside mount</b>	9 ± 10%	91 ± 10%	± 11%	 HG-PA180-9	<a href="#">2</a>
	15 ± 10%	153 ± 10%	± 5%	 HG-PA200, HG-PA201	<a href="#">3</a>
	20 ± 10%	204 ± 10%			
	25 ± 10%	255 ± 10%			
	35 ± 10%	357 ± 10%	± 5%	 HG-PA270	<a href="#">4</a>
45 ± 10%	459 ± 10%				
 <b>Inside mount</b>	9 ± 10%	91 ± 10%	± 11%	 HG-PA210-9	<a href="#">5</a>
	15 ± 10%	153 ± 10%	± 5%	 HG-PA230, HG-PA231	<a href="#">6</a>
	20 ± 10%	204 ± 10%			
	25 ± 10%	255 ± 10%			

Refer to [1](#) : P.15, [2](#) : P.74, [3](#) : P.75, [4](#) : P.76, [5](#) : P.77, [6](#) : P.78

Please use selection tool “SASUGA-kun” for product selection.  
Simulation when using multiple hinges is possible.

Please visit by clicking the banner on the website



[How to Select] Refer to the following 1~3 for model selection.

1. Calculating lid moment

Calculation formula  $Mu = m \times g \times L \times \cos \theta$

- Outside mount type (HG-PA180, HG-PA200, HG-PA201, HG-PA270)
- Inside mount type (HG-PA210, HG-PA230, HG-PA231)

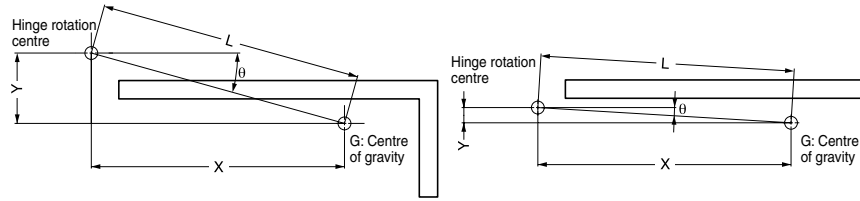

X	Horizontal distance from rotation centre to lid centre of gravity
Y	Vertical distance from rotation centre to lid centre of gravity
L	Distance from rotation centre to lid centre of gravity
$\theta$	Angle from the horizontal line at the rotation centre to lid centre of gravity
m	Lid weight
G	Lid centre of gravity

2. Torque of the hinge (using 2 pcs)

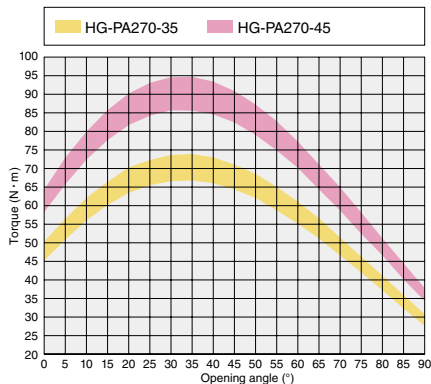
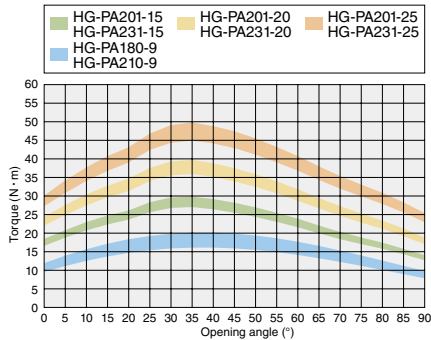
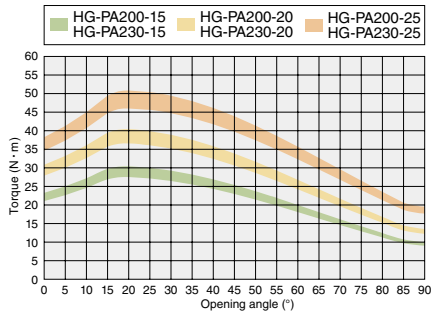

3. Selecting model

Example

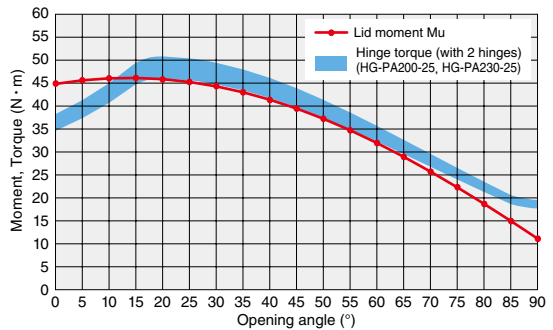

Lid torque and hinge torque should be overlapped as shown on the graph above.

Lid moment  $Mu >$  Hinge torque...Force is applied in the closing direction of lid.  
Lid moment  $Mu <$  Hinge torque...Force is applied in the opening direction of lid.

※Confirm the movement with actual item when the lid moment  $Mu$  is at the upper or lower limit of the torque range of lift assist hinge.

Conditions in the above example : X=43 cm, Y=10.5 cm, L=44.3 cm, W=10.8 kg  
Recommended model : 2 pcs of HG-PA200-25 or HG-PA230-25

TORQUE HINGES

DAMPER HINGES

LIFT ASSIST HINGES

DETENT HINGES

CONCEALED HINGES

BUTT HINGES

PIANO HINGES

STEP HINGES

LIFT-OFF HINGES

PIVOT HINGES

SPRING HINGES

CLEAN ROOM HINGES

HINGES FOR ALUMINIUM FRAME

DROP HINGES

GLASS DOOR HINGES

SPECIAL HINGES

# LIFT-ASSIST HINGE HG-PA230, HG-PA231 Inside Mount



Lift assist  
Soft-close

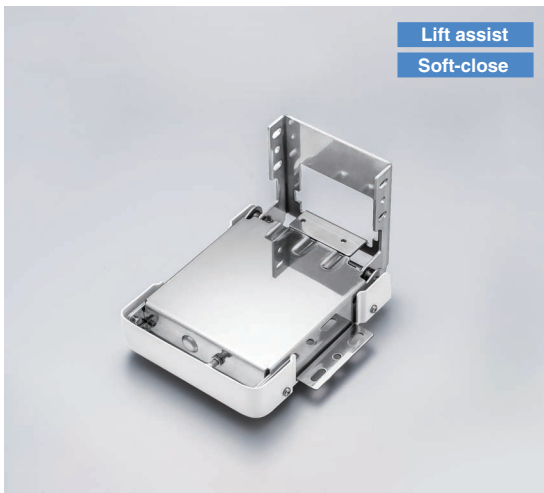

- The torque peaks at 20° or 35° depending on the lid shape (see diagram below).
- Easy to lift heavy top-opening lid with spring tension (lift assist function).
- Smooth and soft-closing movement at the end, preventing lid from slamming shut.
- Torque is adjustable by turning the adjustment screw (±5%).
- Able to limit the 140° opening angle to 55° or 80° with use of the included stopper plate.
- Opening angle can also be restricted between 15° and 90° (made to order).

**[Remarks]**

- Be sure to read the "Cautions" 1.
- For HG-PA230 and HG-PA231, centre-of-gravity positions of the applicable doors are different. Please refer to How to Select 2 for model selection.
- Install a stopper (not included) on the cabinet to prevent from exceeding the operating angle during opening or closing.

**[Operating Range]**



**Video Link**



**S**election Tool  
**Sasuga-kun**  
Applicable Products  
Used for Product Selection & Simulation.  
Available on Web!

LYLotion DesignTEC  
Video Lift Assist

No.	Part Name	Material / Colour
①	Base A	Stainless Steel (SUS430)
②	Base B	
③	Cover	PP/Light Grey
④	Case	Stainless Steel (SUS430)
⑤	Stopper Plate	
-	Slider	POM
-	Spring	Steel (SWO)

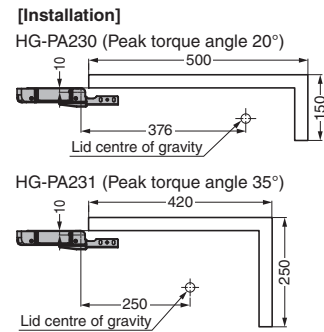
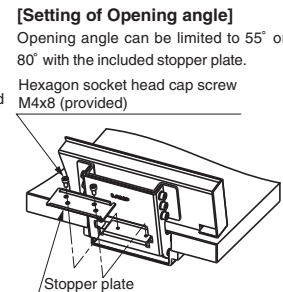
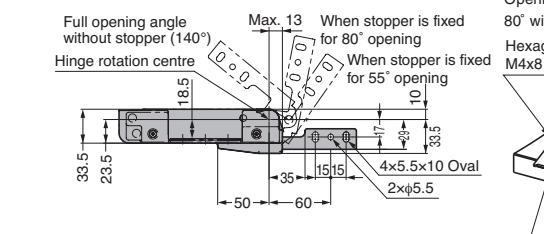
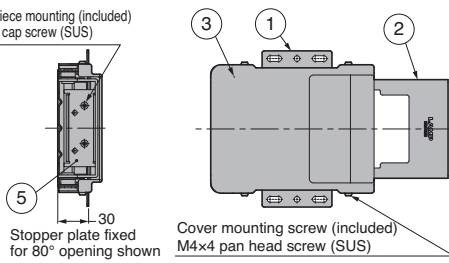
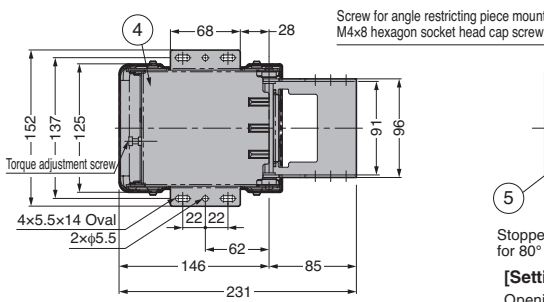
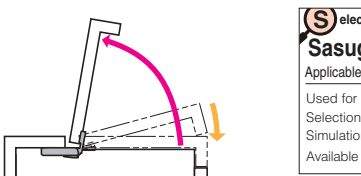

**[Installation]**

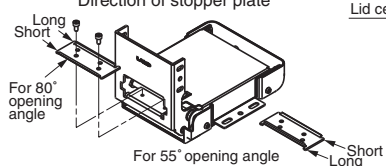
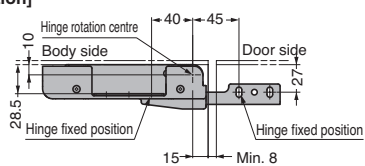

RHS	CAD	Item Code	Item Name	Description	Torque N·m/pc	Torque kgf·cm/pc	Weight (g)	Box (pcs)	Carton (pcs)
G	3D	170-025-671	HG-PA230-15	Peak torque angle 20°	15±10%	153±10%	1296	1	8
G	3D	170-025-672	HG-PA230-20		20±10%	204±10%		1	8
G	3D	170-025-673	HG-PA230-25		25±10%	255±10%		1	8
G	3D	170-029-744	HG-PA231-15	Peak torque angle 35°	15±10%	153±10%		1	8
G	3D	170-029-745	HG-PA231-20		20±10%	204±10%		1	8
G	3D	170-029-746	HG-PA231-25		25±10%	255±10%		1	8

Refer to 1 : P.15, 2 : P.73