

SELF-OPEN MINI DAMPER HINGE

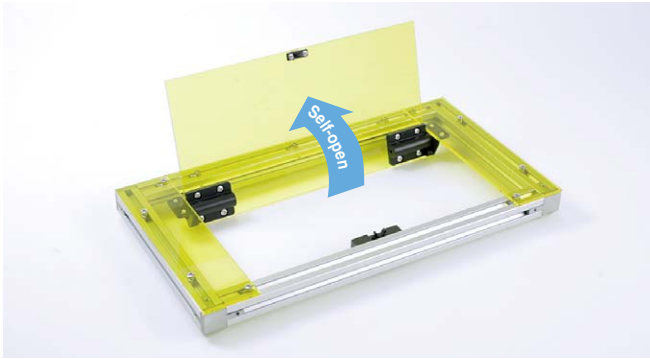

HG-JHS9



Application example with a push-latch.

Features

- Small damper hinge with self-opening function for top-opening lids.
- Using with a push-latch enables pop-up function of the lid.
- Inset use.
- Opening speed of the lid can easily be adjusted with a hex wrench.

Maximum Lid Torque Calculation

$$T = M \times L \times 9.8$$

T : Maximum lid torque (cN-m)

M : Lid weight (kg)

L : Distance from rotation centre to lid centre of gravity (cm)

$$L = D/2 - A$$

D : Lid length (cm)

A : Length of lid back from rotation centre (cm)

t : Door thickness

Video Link



HG-JHS9-S-BL (Side Mount)



HG-JHS9-U-WT (Under Mount)

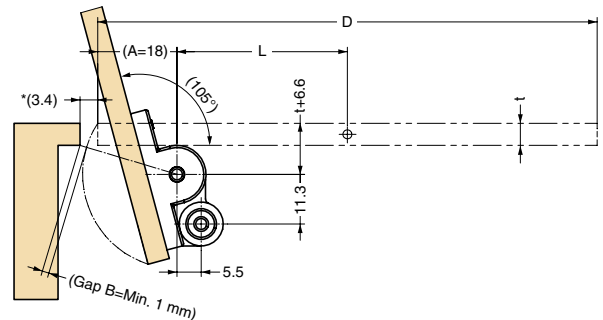

- Make sure that the gap B is Min. 1 mm.
 - Please provide a stopper to hold the lid at the closed position.
- *In case of t = 5 mm, B = 1 mm.

Side Mount Type

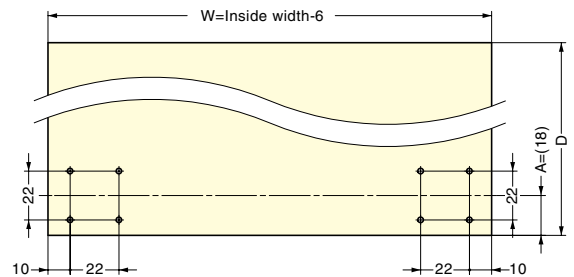
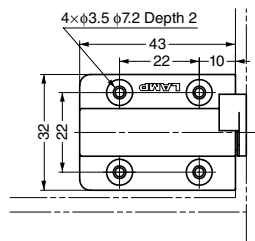
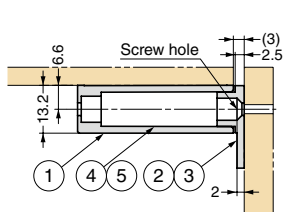

Under Mount Type

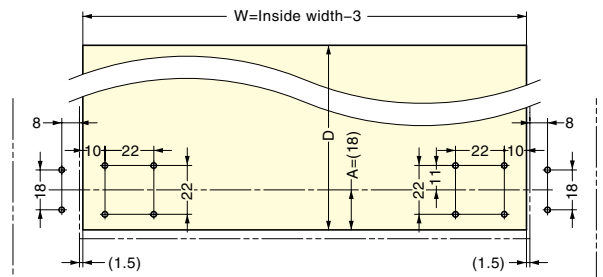
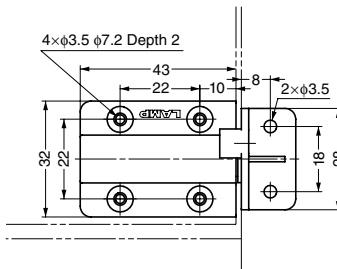
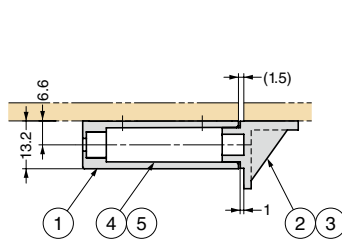

No.	Part Name	Material	Colour
①	Body	Polyacetal (POM)	Black, White
②	Bracket R	PBT	Black, White
③	Bracket L	PBT	Black, White
④	Damper Unit (R)	Polyacetal (POM)	-
⑤	Spring Unit (L)	Zinc Alloy (ZDC)/Stainless Steel	Chromate/-

Item Code	Item Name	Type	Colour	Torque Moment (Per pair)		Weight	Box	Carton
170-028-293	HG-JHS9-S-BL	Side Mount	Black	2.7 - 4.3 cN-m	0.28 - 0.44 kgf-cm	39 g	40 sets	440 sets
170-028-294	HG-JHS9-S-WT	Side Mount	White	2.7 - 4.3 cN-m	0.28 - 0.44 kgf-cm	39 g	40 sets	440 sets
170-028-295	HG-JHS9-U-BL	Under Mount	Black	2.7 - 4.3 cN-m	0.28 - 0.44 kgf-cm	42 g	35 sets	385 sets
170-028-296	HG-JHS9-U-WT	Under Mount	White	2.7 - 4.3 cN-m	0.28 - 0.44 kgf-cm	42 g	35 sets	385 sets