

WIRE MANAGER WSD Dustproof Type



- For simply preventing dust intrusion.
- Nitrile rubber gasket and pile improve sealability and can block gaps caused by size differences or multiple cables.
- Parts replacement or grommet addition can be performed without inserting and removing cables.
- Cables can be easily replaced without using tools during maintenance.
- Can pass through multiple cables of different sizes up to $\phi 20$. For $\phi 20$, up to 3 pcs (WSD-70), 6 pcs (WSD-140) and 12 pcs (WSD-280) can be passed through.
- Gasket tightening force is adjustable in two steps.
- Grounding can be connected from the grommet body fixing screw.

[Applications]

- Control boards, switch boards of processing machines and machine tools, etc.

[Remarks]

- This product is not waterproof and oilproof.

[Sold Separately]

- Cable fastening bracket (WSD-70: 1 pc, WSD-140: up to 2 pcs, WSD-280: up to 4 pcs)
- Wire bracket (for grounding)

[Recommended Screws]

- Cross-recessed head screw M4

[Post-Installation]

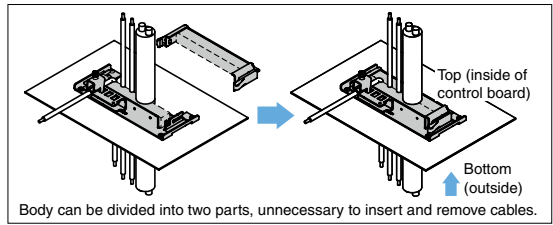

[Body]

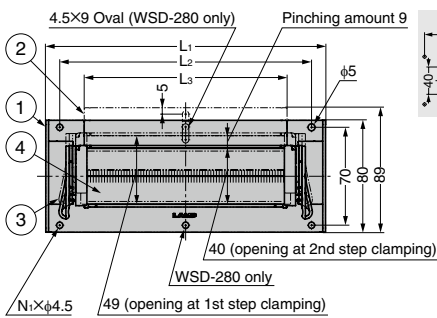

[Cut Out Dimensions]

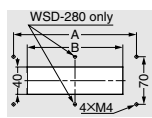

[Gasket Tightening Force Adjustment]

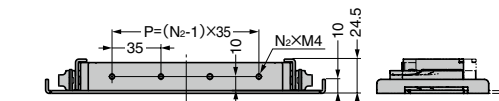
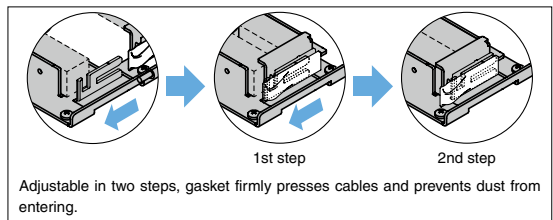

No.	Part Name	Material	Finish / Colour
①	Base Plate	Steel (SPCC)	Nickel
②	Guide Plate		
③	Joint	POM	White
④	Gasket	Nitrile Rubber (NBR), Pile	Black

[Cable Fastening Bracket] Sold Separately

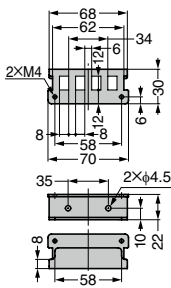

[Parts Included]

- Pan head screw M4 x 4 (SUS) 2 pcs

Part Name	Material	Finish
Body	Steel (SPCC)	Nickel

RoHS	CAD	Item Code	Item Name	Weight (g)	Box (pcs)	Carton (pcs)
RoHS	CAD	210-034-659	WSD-B	61	60	180

[Body]

RoHS	CAD	Item Code	Item Name	L1	L2	L3	P	N1	N2	A	B	Weight (g)	Box (pcs)	Carton (pcs)
RoHS	CAD	210-034-656	WSD-70	130	110	75	35	3	2	110	70	298	1	40
RoHS	CAD	210-034-657	WSD-140	200	180	145	105		4	180	140	433	1	30
RoHS	CAD	210-034-658	WSD-280	340	320	285	245		4	8	320	280	793	1

[Wire Bracket] Sold Separately

※ For Max. $\phi 12$

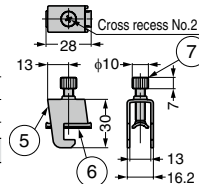

No.	Part Name	Material	Finish
⑤	Body	Steel	Nickel
⑥	Wire Presser	(SPCC)	
⑦	Wire Clamping Bolt	Steel (SWRM)	

RoHS	CAD	Item Code	Item Name	Weight (g)	Box (pcs)	Carton (pcs)
RoHS	CAD	210-024-554	WSM-10	23	50	500