

Series 41 cylinders - Aluminium profile

Double-acting, cushioned, magnetic
 ø 160 - 200 mm

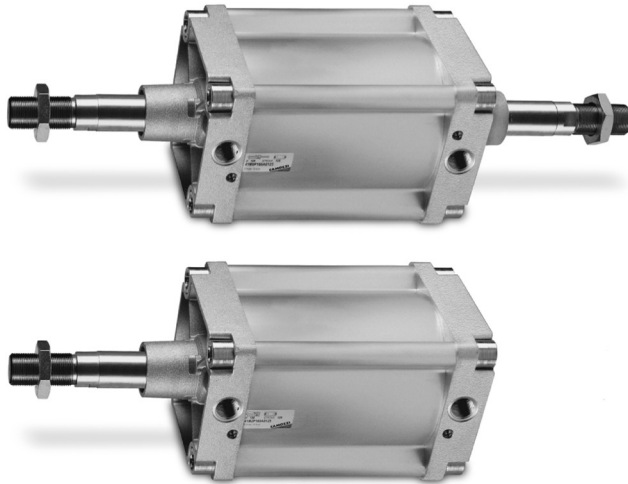

- » In compliance with DIN/ISO 6431/VDMA 24562 standards
- » Rolled stainless steel rod
- » Adjustable pneumatic cushioning
- » Rod scraper in brass

Series 41 cylinders with bores 160 and 200mm have been designed so as to comply with the dimensions laid down in the DIN/ISO 6431 standards. The extruded aluminium tube in this series is regarded as very aesthetically pleasing.

The mounting brackets used on the end-blocks tube are designed in an extremely secure way, making use of the cylinder tie-rods positioned internally and not visible on the assembled cylinders. This cylinder series is normally equipped with adjustable cushioning. Moreover, to reduce the noise of the impact of the piston and end-caps, these cylinders are equipped with a mechanical cushioning.

GENERAL DATA

Type of construction	with tie-rods
Operation	double-acting
Materials	AL end blocks and piston - rolled stainless steel AISI 420B piston rod - zinc-plated steel piston rod nut - anodized AL-profile tube zinc-plated steel tie-rods and tie-rod nuts - NBR rod - piston - cushion seals - brass rod scraper
Mounting	with tie-rods, front flange, rear flange, feet, centre trunnion, front and rear trunnion, swivel combination
Strokes min - max	10 ÷ 2500 mm
Operating temperature	0°C ÷ 80°C (with dry air - 20°C)
Operating pressure	1 ÷ 10 bar
Speed	10 ÷ 500 mm/sec (without load)
Fluid	filtered air, without lubrication. If lubricated air is used, it is recommended to use oil ISOVG32. Once applied the lubrication should never be interrupted.

STANDARD STROKES FOR DOUBLE-ACTING CYLINDERS SERIES 41

* = Double-acting

STANDARD STROKES														
Ø	25	50	75	80	100	125	150	160	200	250	300	320	400	500
160		*			*		*		*				*	*
200		*			*				*					

CODING EXAMPLE

41	M	2	P	160	A	0200	
-----------	----------	----------	----------	------------	----------	-------------	--

41	SERIES
M	VERSION M = standard magnetic
2	OPERATION 2 = double-acting, front and rear cushions 3 = double-acting, no cushion 4 = double-acting, rear cushions 5 = double-acting, front cushion 6 = double-acting, through-rod, front and rear cushions 8 = double-acting, through-rod, no cushion
	PNEUMATIC SYMBOLS CD09 CD08 CD10 CD11 CD13 CD12
P	MATERIALS P = see the general data on page 1/1.15.01 R = stainless steel AISI 420B tie-rods, stainless steel AISI 303 tie-rod nuts C = rolled stainless steel AISI 303 piston rod, stainless steel AISI 304 piston rod nut U = rolled stainless steel AISI 303 piston rod, stainless steel AISI 304 piston rod nut, stainless steel AISI 420B tie-rods, stainless steel AISI 303 tie-rod nuts W = rolled stainless steel AISI 304 piston rod, stainless steel AISI 304 piston rod nut, stainless steel AISI 420B tie-rods, stainless steel AISI 303 tie-rod nuts
160	BORE 160 = 160 mm - 200 = 200 mm
A	TYPE OF DESIGN A = tie-rods F = cylinder with centre trunnion
0200	STROKE (see the table) = standard V = FKM rod seals W = all FKM seals +130°C C = PU coated cylinder. Color: Grey * G = with brass rod scraper (chrome plated stainless steel AISI 420B rod, NBR rod seal) (_ _ _) = extended piston rod _ _ _ mm * Version C: available on request. For further information, please contact our technical dept.

PNEUMATIC SYMBOLS

The pneumatic symbols which have been indicated in the CODING EXAMPLE are shown below.

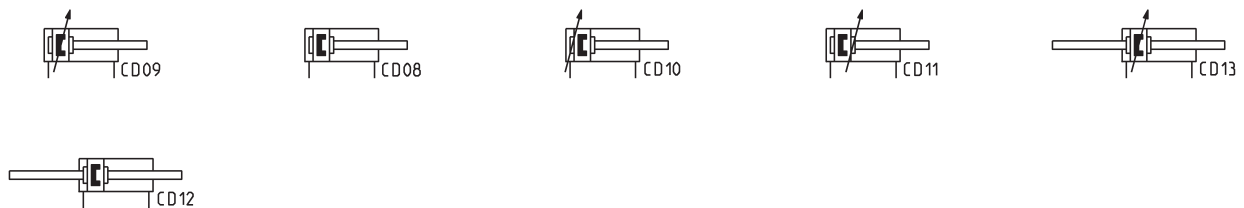

ACCESSORIES FOR CYLINDERS SERIES 41

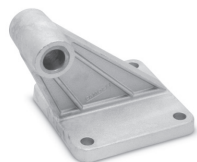

Clevis pin Mod. S

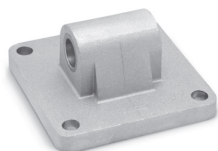

90° swivel combination Mod. ZS

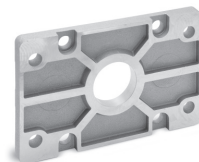

Rear trunnion, male Mod. L



Front and rear flange Mod. D-E

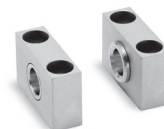

Counter bracket for centre trunnion Mod. BF



Centre trunnion Mod. F



Foot mount Mod. B

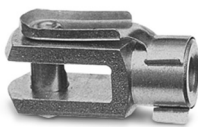

Rod fork end Mod. G

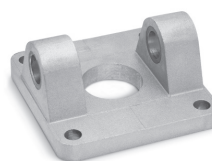

Front and rear female trunnion Mod. C-H



Swivel ball joint Mod. GA



Swivel combination Mod. C+L+S



Piston rod lock nut Mod. U



Self aligning rod Mod. GK



All accessories are supplied separately, except for the piston rod lock nut Mod. U

Cylinders Series 41



+ = add the stroke

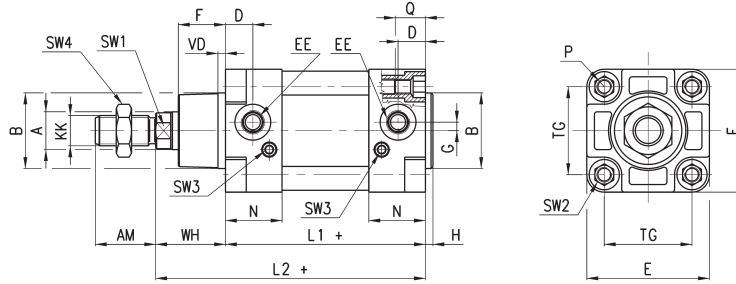

DIMENSIONS

Ø	A	KK	B	D	G	F	AM	H	EE	WH	L1+	L2+	VD	N	P	Q	TG	E	SW1	SW2	SW3	SW4	front/rear cushion strokes
160	40	M36x2	65	25	12	53.5	72	6	G3/4	80	180	260	6	45	M16	26	140	176	36	17	4	55	29 / 36
200	40	M36x2	75	25	12	63.5	72	6	G3/4	95	180	275	6	45	M16	26	175	216	36	17	4	55	44 / 42

Cylinders Series 41 - through-rod



+ = add the stroke once
++ = add the stroke twice

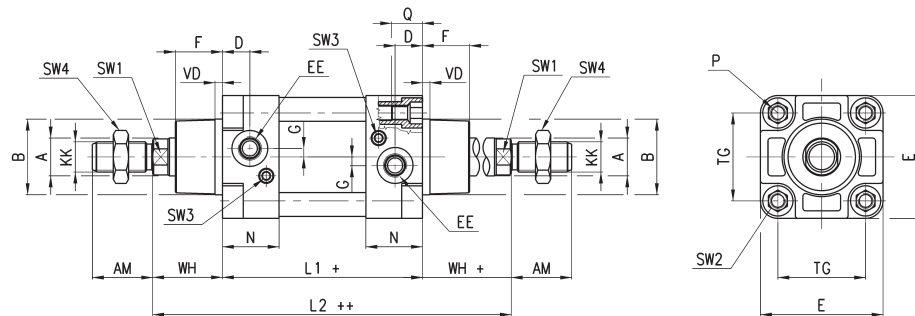

DIMENSIONS

Ø	A	KK	B	D	G	F	AM	EE	WH	L1+	L2++	VD	N	P	Q	TG	E	SW1	SW2	SW3	SW4	front/rear cushion strokes
160	40	M36x2	65	25	12	53.5	72	G3/4	80	180	340	6	45	M16	26	140	176	36	17	4	55	29 / 36
200	40	M36x2	75	25	12	63.5	72	G3/4	95	180	370	6	45	M16	26	175	216	36	17	4	55	44 / 42

Cylinders Series 41 with centre trunnion Mod. F

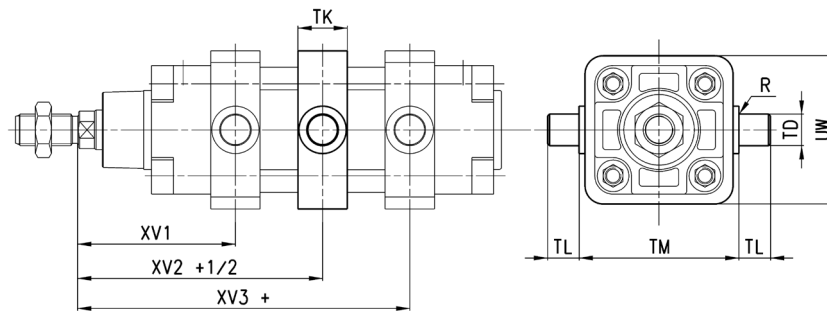

+ = add the stroke
 + 1/2 = add the stroke half

DIMENSIONS

∅	XV1	XV2	XV3	TM	TK	TD	TL	UW	R
160	145	170	195	200	40	32	32	200	0,2
200	160	185	210	250	40	32	32	250	0,2

Foot mount Mod. B

Material: black-painted steel
(cataphoresis)
Supplied with:
2x feet
4x screws



+ = add the stroke

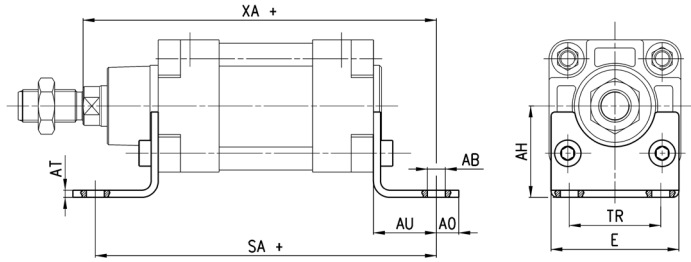

DIMENSIONS

Mod.	∅	AT	SA+	XA+	TR	E	∅ _{AB}	AH	AO	AU
B-41-160	160	10	300	320	115	175	18.5	115	25	60
B-41-200	200	12	320	345	135	238	24	135	35	70

Front and rear flange Mod. D-E

Material: Aluminium.
Supplied with:
1x flange
4x screws

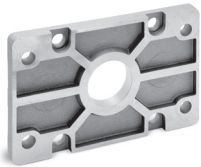

+ = add the stroke

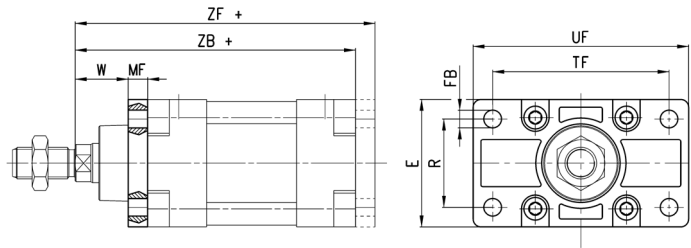

DIMENSIONS

Mod.	∅	W	MF	ZB+	TF	R	UF	E	∅ _{FB}	ZF+
D-E-41-160	160	60	20	260	230	115	276	175	18	280
D-E-41-200	200	70	25	275	270	135	312	215	22	300

Front and rear female trunnion Mod. C-H

Material: Aluminium.
Supplied with:
1x female trunnion
4x screws

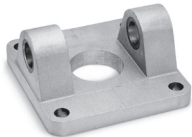

+ = add the stroke

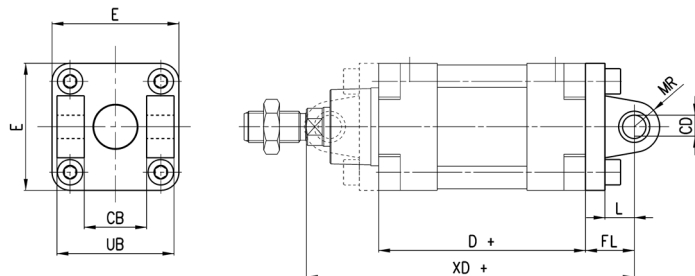

DIMENSIONS

Mod.	∅	∅ _{CD}	L	FL	D+	XD+	MR	E	CB	UB
C-H-41-160	160	30	35	55	180	315	30	175	90	170
C-H-41-200	200	30	35	60	180	335	30	215	90	170

Rear male trunnion Mod. L

Material: Aluminium
 Supplied with:
 1x male trunnion
 4x screws

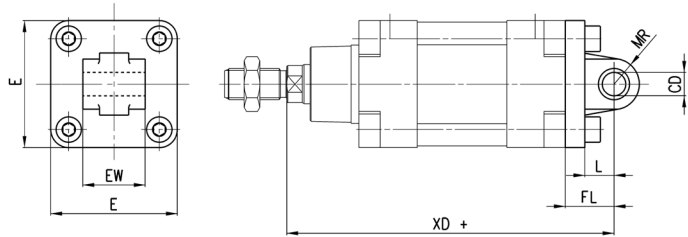
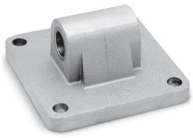

+ = add the stroke

DIMENSIONS

Mod.	∅	∅CD	L	FL	XD+	MR	E	EW ^{-0.5-1.2}
L-41-160	160	30	35	55	315	30	175	90
L-41-200	200	30	35	60	335	30	215	90

Centre trunnion Mod. F

Material: white zinc-plated steel.
 Supplied with:
 1x centre trunnion
 4x clamping elements
 4x locking screws

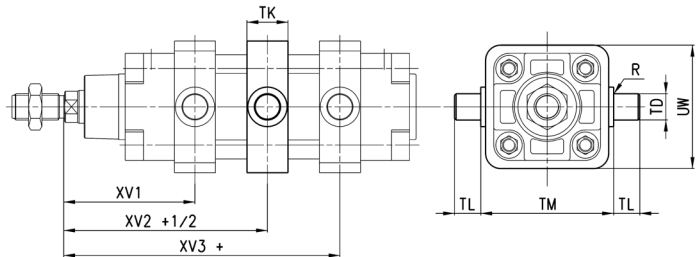

+ = add the stroke

DIMENSIONS

Mod.	∅	XV1	XV+1/2	XV3+	TM	h	∅TD	TL	UW	R
F-41-160	160	145	170	195	200	40	32	32	200	0.2
F-41-200	200	160	185	210	250	40	32	32	250	0.2

90° Swivel combination Mod. ZS*

Material: Aluminium
 * not according to standard

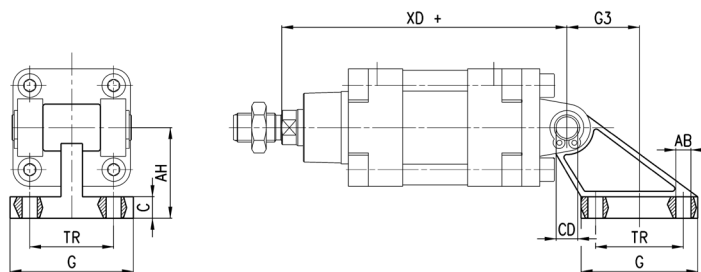
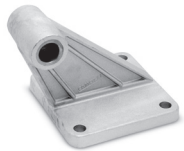

+ = add the stroke

DIMENSIONS

Mod.	∅	TR	∅AB	AH	C	G	∅CD	XD+	G3
ZS-160	160	140	18	140	20	180	30	315	105
ZS-200	200	175	18	140	25	220	30	335	125

Swivel combination Mod. C+L+S

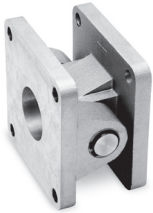

+ = add the stroke

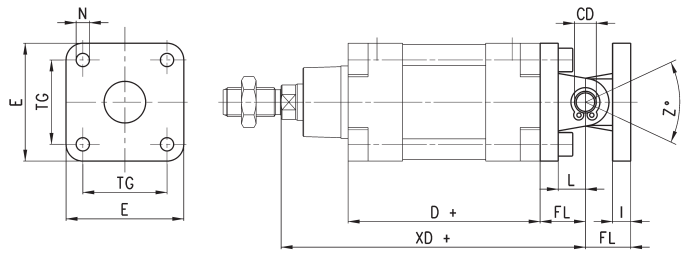

DIMENSIONS

Mod.	∅	∅CD	L	FL	D+	XD+	TG	E	∅N	I	Z° (max)
C+L+S	160	30	35	55	180	315	140	175	17	20	25
C+L+S	200	30	35	60	180	335	175	215	17	25	20

Counter bracket for centre trunnion Mod. BF

Material: Aluminium.
Supplied with:
2x supports

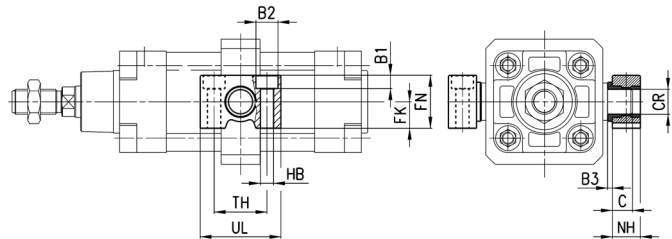
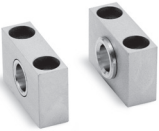

DIMENSIONS

Mod.	∅	∅CR	NH	C	B3	TH	UL	FK	FN	B1	∅B2	∅HB
BF-160-200	160-200	32	35	17,5	4	60	92	30	60	16	26	18

Rod fork end Mod. G

ISO 8140.
Material: zinc-plated steel.

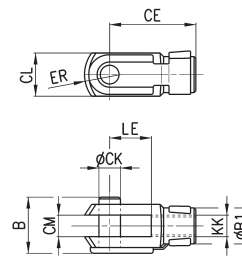

DIMENSIONS

Mod.	∅	∅CK	LE	CM	CL	ER	CE	KK	B	∅B1
G-160-200	160-200	35	72	35	70	44	144	M36X2	92	60

Swivel ball joint Mod. GA

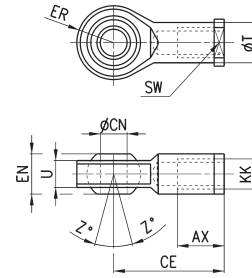
 ISO 8139.
 Material: zinc-plated steel.

DIMENSIONS											
Mod.	Ø	øCN	U	EN	ER	AX	CE	KK	ØT	Z	SW
GA-160-200	160-200	35	28	43	40	56	125	M36x2	46	6	50

Clevis pin Mod. S

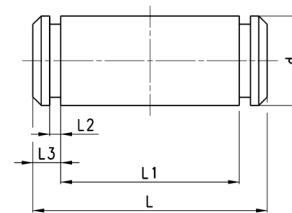
 Supplied with:
 1x centering pin in
 stainless steel 303
 2x seeger in steel

DIMENSIONS						
Mod.	Ø	d	L	L1	L2	L3
S-160-200	160-200	30	180.5	172	1.6	4.25

Piston rod lock nut Mod. U

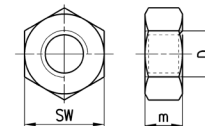
 ISO 4035
 Material: zinc-plated steel

DIMENSIONS				
Mod.	Ø	D	m	SW
U-160-200	160-200	M36x2	14	55

Self aligning rod Mod. GK

Material: zama and zinc-plated steel.

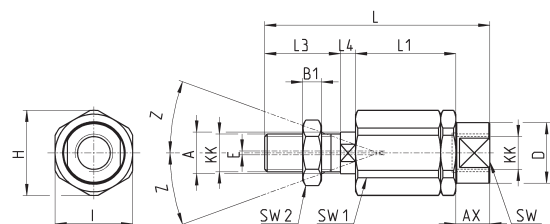

DIMENSIONS																	
Mod.	Ø	KK	L	L1	L3	L4	øA	øD	H	I	SW	SW1	SW2	B1	AX	Z	E
GK-160-200	160-200	M36x2	190	77	72	15.5	39	57	75	70	54	32	55	14	68	4	2