

# vacuum area gripper

## FMP-SW140 1432 3R54 SPB2-40P G60

Part no.:10.01.38.00457

<https://www.schmalz.com/10.01.38.00457>

Homepage > Vacuum Technology for Automation > Vacuum Components > Area Gripping Systems and End Effectors > Vacuum Area Gripping System FXP/FMP > Area Gripping Systems FMP > FMP-SW140 1432 3R54 SPB2-40P G60

### Vacuum area gripping system for external vacuum generator, with flow resistors

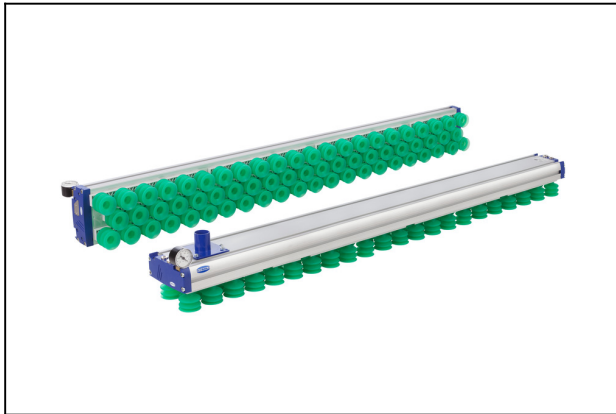

Length L: 1432 mm  
 Width B: 130 mm  
 Arrangement: 3 rows, 54mm  
 Suct. cups: Bellows suct. cup SPB2  
 Diameter Ds: 40 mm  
 Nozzle diameter: 1.4 mm  
 Fitting version: Straight  
 External diameter D: 60 mm  
 Shape: Push In  
 Weight: 7 kg

### Design Data

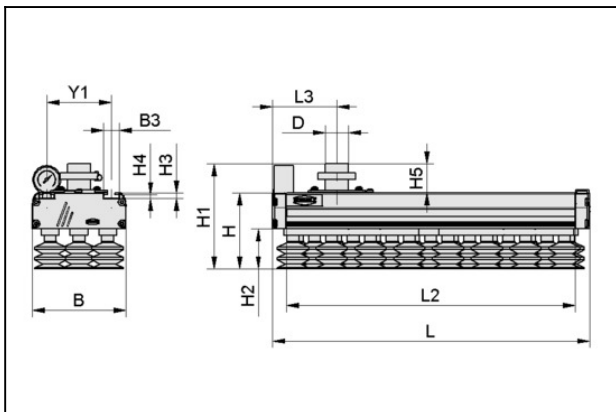

Attribute	Value
B	130 mm
B3	21.6 mm
Ds	40 mm
H	104.8 mm
H1	150.4 mm
H2	55 mm
H3	7.7 mm
H4	5.5 mm
H5	46 mm
L	1,432 mm
L2	1,392 mm
L3	90 mm

# vacuum area gripper

## FMP-SW140 1432 3R54 SPB2-40P G60

Part no.:10.01.38.00457

<https://www.schmalz.com/10.01.38.00457>



Attribute	Value
Valve type	SW
Y1	90 mm

### Technical Data

Attribute	Value
Arrangement	3R54
Number of suction cells	77
Suction force	680 N
Weight	7 kg
Sealing element	Suction Cups
Erforderl. Saugleistung für pu = -0,25 bar	1,050 l/min

For compressed air with 5.5 bar input pressure At -0.25 bar and with the gripper fully covered by a workpiece typical for the application (wooden board with structured surface) The external vacuum generator used must supply at least the specified suction flow (at the vacuum connection piece of the FMP) at -0.25 bar but max. 135 % of the specified suction flow

### Spare Parts

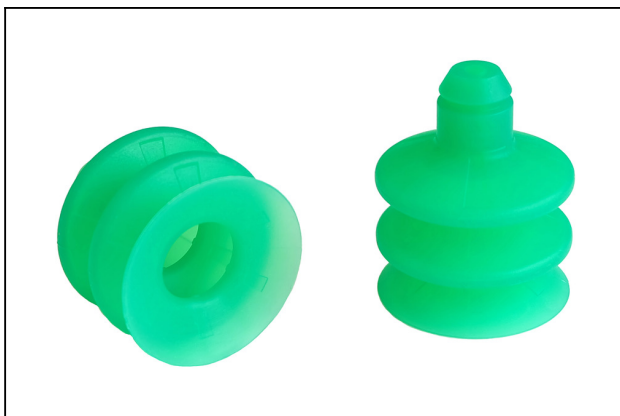

#### SPB2 40 SI-55 P

Part no.10.01.06.03126

Bellows suction cup (round) with 2.5 corr. for dynamic handling of cardboard and rigid packaging

Size: 40

Suction cup material: Silicone SI

Material hardness: 55 °Sh

Number of folds: 2.5

Shape: Push In

#### Contact to Schmalz

J. Schmalz GmbH | Johannes-Schmalz-Straße, 72293 Glatten, Deutschland | +49 7443 2403-102 | [customercenter@schmalz.de](mailto:customercenter@schmalz.de)

## vacuum area gripper

FMP-SW140 1432 3R54 SPB2-40P G60

Part no.:10.01.38.00457

<https://www.schmalz.com/10.01.38.00457>

### Accessories



#### **ASK WB-M8-4 5000 K-4P**

Part no.10.06.02.00032

Connection cable

Interface Connection 1:

Elbow fem con M8, 4 pol

Cable length: 5000 mm

Interface Connection 2: Cable 4

Material: PUR-Cable

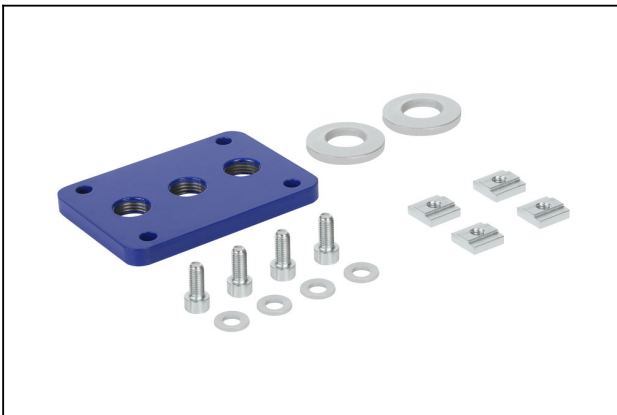

#### **FLAN-PL 120x85x10 ST FLGR**

Part no.10.01.10.05701

Flange plate

Length L: 120 mm

Width B: 85 mm

Height H: 10 mm

Material: Steel

for: Large-area vacuum gripper



#### **FLK G1/2-IG G1/2-AG**

Part no.10.01.03.00175

Flexible suction cup mounting for adaptation to sloping surfaces

Thread G1: G1/2"-F

Thread G2: G1/2"-M

Ambient temperature: 0 ... 70 °C

## vacuum area gripper

FMP-SW140 1432 3R54 SPB2-40P G60

Part no.:10.01.38.00457

<https://www.schmalz.com/10.01.38.00457>



### **FST-FLEX 25 HD1 G1/2-AG G3/8-IG**

Part no.10.01.10.05697

Spring plunger with both-way damping and height compensation, heavy-duty

Spring stroke Z: 25 mm

Shape: Heavy Duty 1 sp. plug  
for: Mounting section



### **FST-FLEX 25 HD2 G1/2-AG G3/8-IG**

Part no.10.01.10.05695

Spring plunger with both-way damping and height compensation, heavy-duty

Spring stroke Z: 25 mm

Shape: Heavy Duty 2 sp. plug  
for: Mounting section



### **FST-FLEX 50 HD1 G1/2-AG G3/8-IG**

Part no.10.01.10.05687

Spring plunger with both-way damping and height compensation, heavy-duty

Spring stroke Z: 50 mm

Shape: Heavy Duty 1 sp. plug  
for: Mounting section

## vacuum area gripper

FMP-SW140 1432 3R54 SPB2-40P G60

Part no.:10.01.38.00457

<https://www.schmalz.com/10.01.38.00457>



### **FST-FLEX 50 HD2 G1/2-AG G3/8-IG**

Part no.10.01.10.05168

Spring plunger with both-way damping and height compensation, heavy-duty

Spring stroke Z: 50 mm

Shape: Heavy Duty 2 sp. plug  
for: Mounting section



### **FST-FLEX 75 HD1 G1/2-AG G3/8-IG**

Part no.10.01.10.05698

Spring plunger with both-way damping and height compensation, heavy-duty

Spring stroke Z: 75 mm

Shape: Heavy Duty 1 sp. plug  
for: Mounting section



### **FST-FLEX 75 HD2 G1/2-AG G3/8-IG**

Part no.10.01.10.05696

Spring plunger with both-way damping and height compensation, heavy-duty

Spring stroke Z: 75 mm

Shape: Heavy Duty 2 sp. plug  
for: Mounting section

## vacuum area gripper

### FMP-SW140 1432 3R54 SPB2-40P G60

Part no.:10.01.38.00457

<https://www.schmalz.com/10.01.38.00457>



#### **FST-STARR 25 HD1 G1/2-AG G3/8-IG**

Part no.10.01.10.05810

Spring plunger with both-way damping and height compensation, heavy-duty

Spring stroke Z: 25 mm

Shape: Heavy Duty 1 spr. plunger  
for: Mounting section



#### **FST-STARR 25 HD2 G1/2-AG G3/8-IG**

Part no.10.01.10.05806

Spring plunger with both-way damping and height compensation, heavy-duty

Spring stroke Z: 25 mm

Shape: Heavy Duty 2 spr. plunger  
for: Mounting section



#### **FST-STARR 50 HD1 G1/2-AG G3/8-IG**

Part no.10.01.10.05809

Spring plunger with both-way damping and height compensation, heavy-duty

Spring stroke Z: 50 mm

Shape: Heavy Duty 1 spr. plunger  
for: Mounting section

## vacuum area gripper

### FMP-SW140 1432 3R54 SPB2-40P G60

Part no.:10.01.38.00457

<https://www.schmalz.com/10.01.38.00457>



#### **FST-STARR 50 HD2 G1/2-AG G3/8-IG**

Part no.10.01.10.05805

Spring plunger with both-way damping and height compensation, heavy-duty

Spring stroke Z: 50 mm

Shape: Heavy Duty 2 spr. plunger  
for: Mounting section



#### **FST-STARR 75 HD1 G1/2-AG G3/8-IG**

Part no.10.01.10.05808

Spring plunger with both-way damping and height compensation, heavy-duty

Spring stroke Z: 75 mm

Shape: Heavy Duty 1 spr. plunger  
for: Mounting section



#### **FST-STARR 75 HD2 G1/2-AG G3/8-IG**

Part no.10.01.10.05803

Spring plunger with both-way damping and height compensation, heavy-duty

Spring stroke Z: 75 mm

Shape: Heavy Duty 2 spr. plunger  
for: Mounting section

## vacuum area gripper

FMP-SW140 1432 3R54 SPB2-40P G60

Part no.:10.01.38.00457

<https://www.schmalz.com/10.01.38.00457>

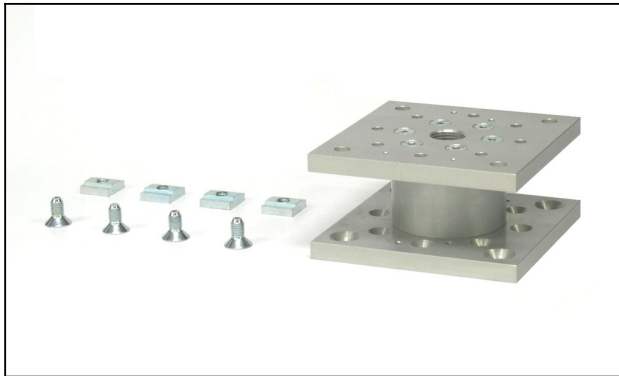

### **MOD-FLAN 120x120x60 FXP-FMP**

Part no.10.01.21.00244

Flange module

Length L: 120 mm

Width B: 120 mm

Height H: 60 mm

for: Large-area vac grip FXP-FMP

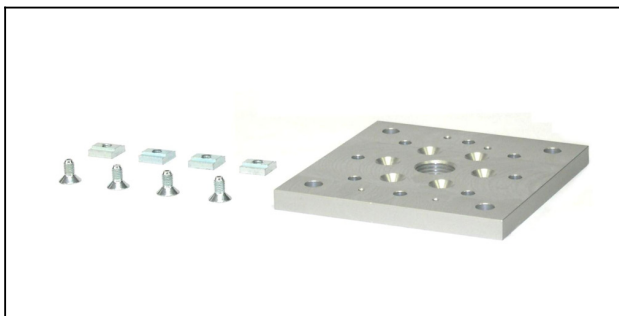

### **SET FXC-FMC**

Part no.10.01.21.01291

Mounting set

for: Large-area vac grip FXC-FMC

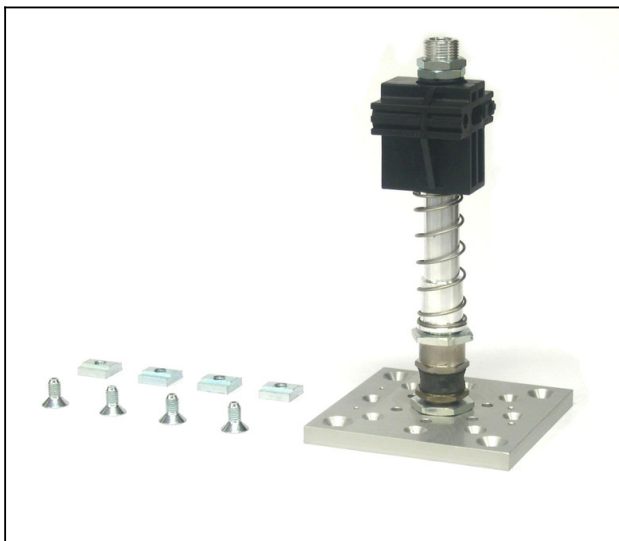

### **SET FXP-FMP**

Part no.10.01.21.02407

Mounting set

for: Large-area vac grip FXP-FMP



## vacuum area gripper

FMP-SW140 1432 3R54 SPB2-40P G60

Part no.:10.01.38.00457

<https://www.schmalz.com/10.01.38.00457>



### SET FXP-FMP 4xNUT-STEI

Part no.10.01.21.00243

Mounting set

for: area gripper FXP-FMP

Size: 4xNUT-STEI

Connection 1: M8



### VAM 40 V U

Part no.10.07.02.00046

Vacuum gauge (manometer) for analogue measurement and monitoring of the vacuum

External diameter D: 40 mm

Measuring range: -1.00 ... 0.00 bar

Shape: Connection at bottom

Vacuum connection: G1/8"-M

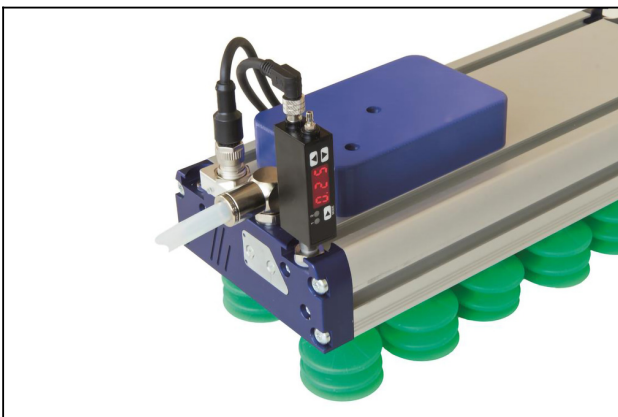

### VS-MONT 50x15.8x25 VS

Part no.10.06.02.00343

Vacuum switch (inst)

Length L: 50 mm

Width B: 15.8 mm

Height H: 25 mm

for: Vacuum switch

SO: Standing mountable

## vacuum area gripper

FMP-SW140 1432 3R54 SPB2-40P G60

Part no.:10.01.38.00457

<https://www.schmalz.com/10.01.38.00457>



### **VS-MONT 76.5x19 VSi FXP-FMP**

Part no.10.01.38.02485

Vacuum switch (inst)

Length L: 76.5 mm

Width B: 19 mm

with: Vacuum and pressure switch

for: area gripper FXP-FMP

SO: Vertical mountable