

vacuum area gripper

FMP-SW90 640 5R36 SPB2-20P F G32

Part no.:10.01.38.00490

<https://www.schmalz.com/10.01.38.00490>

Homepage > Vacuum Technology for Automation > Vacuum Components > Area Gripping Systems and End Effectors > Vacuum Area Gripping System FXP/FMP > Area Gripping Systems FMP > FMP-SW90 640 5R36 SPB2-20P F G32

Vacuum area gripping system for external vacuum generator, with flow resistors

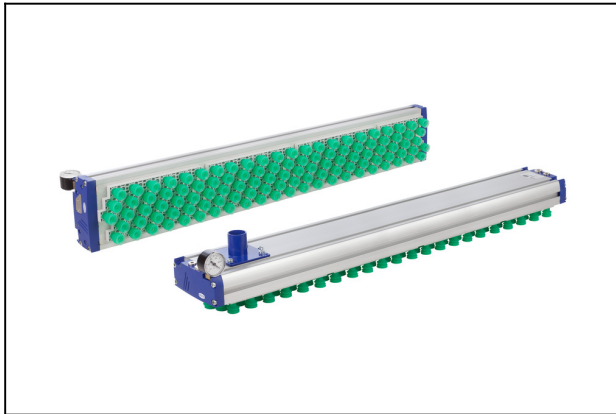

Length L: 640 mm
 Width B: 130 mm
 Arrangement: 5 rows, 36mm
 Suct. cups: Bellows suct. cup SPB2
 Diameter Ds: 20 mm
 with: Filter
 Nozzle diameter: 0.9 mm
 Fitting version: Straight
 External diameter D: 32 mm
 Shape: Push In
 Weight: 3.5 kg

Design Data

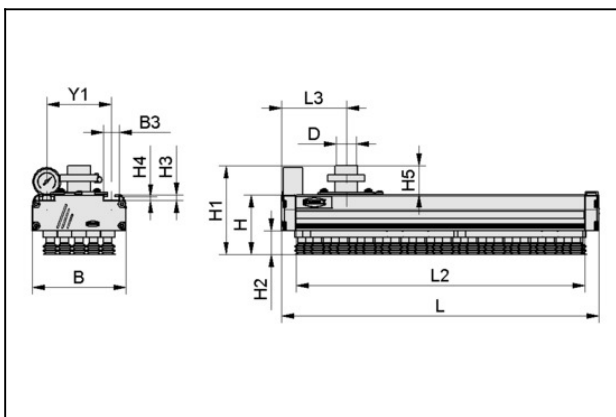

Attribute	Value
B	130 mm
B3	21.6 mm
Ds	20 mm
H	82.7 mm
H1	123.2 mm
H2	33 mm
H3	7.7 mm
H4	5.5 mm
H5	41 mm
L	640 mm
L2	600 mm

Contact to Schmalz

J. Schmalz GmbH | Johannes-Schmalz-Straße, 72293 Glatten, Deutschland | +49 7443 2403-102 | customercenter@schmalz.de

vacuum area gripper

FMP-SW90 640 5R36 SPB2-20P F G32

Part no.:10.01.38.00490

<https://www.schmalz.com/10.01.38.00490>



Attribute	Value
L3	90 mm
Valve type	SW
Y1	90 mm

Technical Data

Attribute	Value
Arrangement	5R36
Number of suction cells	82
Suction force	210 N
Add. function	Filter
Weight	3.5 kg
Sealing element	Suction Cups
Erforderl. Saugleistung für $p_u = -0,25$ bar	450 l/min

For compressed air with 5.5 bar input pressure At -0.25 bar and with the gripper fully covered by a workpiece typical for the application (wooden board with structured surface) The external vacuum generator used must supply at least the specified suction flow (at the vacuum connection piece of the FMP) at -0.25 bar but max. 135 % of the specified suction flow

Accessories

Contact to Schmalz

J. Schmalz GmbH | Johannes-Schmalz-Straße, 72293 Glatten, Deutschland | +49 7443 2403-102 | customercenter@schmalz.de

vacuum area gripper

FMP-SW90 640 5R36 SPB2-20P F G32

Part no.:10.01.38.00490

<https://www.schmalz.com/10.01.38.00490>



ASK WB-M8-4 5000 K-4P

Part no.10.06.02.00032

Connection cable

Interface Connection 1:

Elbow fem con M8, 4 pol

Cable length: 5000 mm

Interface Connection 2: Cable 4

Material: PUR-Cable



EMVP 25 24V-DC 3/2 NO/NC

Part no.10.05.02.00151

Solenoid valve EMVP for vacuum, pneumatic pilot control

Nominal size: 25 mm

Voltage: 24V - DC

Function: 3/2-way valve

Control: Optionally NO/NC

Connecting thread: G1"-F

Nominal flow rate: 90 m³/h

Weight: 0.52 kg

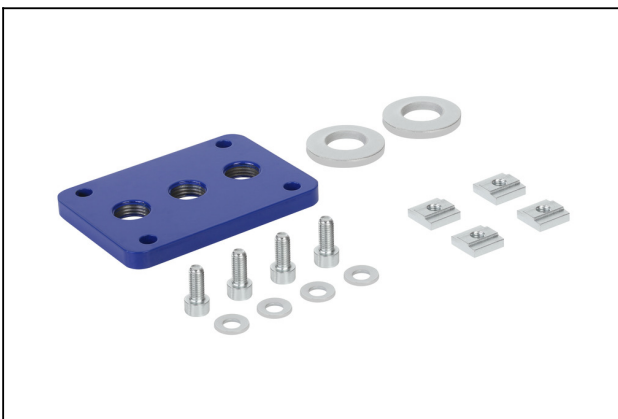

FLAN-PL 120x85x10 ST FLGR

Part no.10.01.10.05701

Flange plate

Length L: 120 mm

Width B: 85 mm

Height H: 10 mm

Material: Steel

for: Large-area vacuum gripper

vacuum area gripper

FMP-SW90 640 5R36 SPB2-20P F G32

Part no.:10.01.38.00490

<https://www.schmalz.com/10.01.38.00490>



FLK G1/2-IG G1/2-AG

Part no.10.01.03.00175

Flexible suction cup mounting for adaptation to sloping surfaces

Thread G1: G1/2"-F

Thread G2: G1/2"-M

Ambient temperature: 0 ... 70 °C



FST-FLEX 25 HD1 G1/2-AG G3/8-IG

Part no.10.01.10.05697

Spring plunger with both-way damping and height compensation, heavy-duty

Spring stroke Z: 25 mm

Shape: Heavy Duty 1 sp. plug
for: Mounting section



FST-FLEX 25 HD2 G1/2-AG G3/8-IG

Part no.10.01.10.05695

Spring plunger with both-way damping and height compensation, heavy-duty

Spring stroke Z: 25 mm

Shape: Heavy Duty 2 sp. plug
for: Mounting section

vacuum area gripper

FMP-SW90 640 5R36 SPB2-20P F G32

Part no.:10.01.38.00490

<https://www.schmalz.com/10.01.38.00490>



FST-FLEX 50 HD1 G1/2-AG G3/8-IG

Part no.10.01.10.05687

Spring plunger with both-way damping and height compensation, heavy-duty

Spring stroke Z: 50 mm

Shape: Heavy Duty 1 sp. plug
for: Mounting section



FST-FLEX 50 HD2 G1/2-AG G3/8-IG

Part no.10.01.10.05168

Spring plunger with both-way damping and height compensation, heavy-duty

Spring stroke Z: 50 mm

Shape: Heavy Duty 2 sp. plug
for: Mounting section



FST-FLEX 75 HD1 G1/2-AG G3/8-IG

Part no.10.01.10.05698

Spring plunger with both-way damping and height compensation, heavy-duty

Spring stroke Z: 75 mm

Shape: Heavy Duty 1 sp. plug
for: Mounting section

vacuum area gripper

FMP-SW90 640 5R36 SPB2-20P F G32

Part no.:10.01.38.00490

<https://www.schmalz.com/10.01.38.00490>



FST-FLEX 75 HD2 G1/2-AG G3/8-IG

Part no.10.01.10.05696

Spring plunger with both-way damping and height compensation, heavy-duty

Spring stroke Z: 75 mm

Shape: Heavy Duty 2 sp. plug
for: Mounting section



FST-STARR 25 HD1 G1/2-AG G3/8-IG

Part no.10.01.10.05810

Spring plunger with both-way damping and height compensation, heavy-duty

Spring stroke Z: 25 mm

Shape: Heavy Duty 1 spr. plunger
for: Mounting section



FST-STARR 25 HD2 G1/2-AG G3/8-IG

Part no.10.01.10.05806

Spring plunger with both-way damping and height compensation, heavy-duty

Spring stroke Z: 25 mm

Shape: Heavy Duty 2 spr. plunger
for: Mounting section

vacuum area gripper FMP-SW90 640 5R36 SPB2-20P F G32

Part no.:10.01.38.00490

<https://www.schmalz.com/10.01.38.00490>



FST-STARR 50 HD1 G1/2-AG G3/8-IG

Part no.10.01.10.05809

Spring plunger with both-way damping and height compensation, heavy-duty

Spring stroke Z: 50 mm

Shape: Heavy Duty 1 spr. plunger
for: Mounting section



FST-STARR 50 HD2 G1/2-AG G3/8-IG

Part no.10.01.10.05805

Spring plunger with both-way damping and height compensation, heavy-duty

Spring stroke Z: 50 mm

Shape: Heavy Duty 2 spr. plunger
for: Mounting section



FST-STARR 75 HD1 G1/2-AG G3/8-IG

Part no.10.01.10.05808

Spring plunger with both-way damping and height compensation, heavy-duty

Spring stroke Z: 75 mm

Shape: Heavy Duty 1 spr. plunger
for: Mounting section

vacuum area gripper

FMP-SW90 640 5R36 SPB2-20P F G32

Part no.:10.01.38.00490

<https://www.schmalz.com/10.01.38.00490>



FST-STARR 75 HD2 G1/2-AG G3/8-IG

Part no.10.01.10.05803

Spring plunger with both-way damping and height compensation, heavy-duty

Spring stroke Z: 75 mm

Shape: Heavy Duty 2 spr. plunger
for: Mounting section

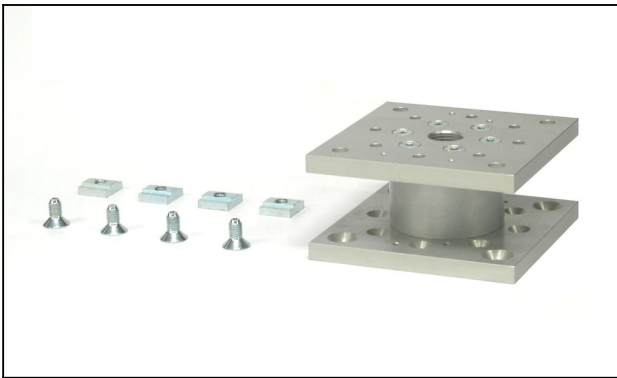

MOD-FLAN 120x120x60 FXP-FMP

Part no.10.01.21.00244

Flange module

Length L: 120 mm

Width B: 120 mm

Height H: 60 mm

for: Large-area vac grip FXP-FMP



SET FXC-FMC

Part no.10.01.21.01291

Mounting set

for: Large-area vac grip FXC-FMC

vacuum area gripper

FMP-SW90 640 5R36 SPB2-20P F G32

Part no.:10.01.38.00490

<https://www.schmalz.com/10.01.38.00490>



SET FXP-FMP

Part no.10.01.21.02407

Mounting set

for: Large-area vac grip FXP-FMP



SET FXP-FMP 4xNUT-STEI

Part no.10.01.21.00243

Mounting set

for: area gripper FXP-FMP

Size: 4xNUT-STEI

Connection 1: M8



VAM 40 V U

Part no.10.07.02.00046

Vacuum gauge (manometer) for analogue measurement and monitoring of the vacuum

External diameter D: 40 mm

Measuring range: -1.00 ... 0.00 bar

Shape: Connection at bottom

Vacuum connection: G1/8"-M

vacuum area gripper

FMP-SW90 640 5R36 SPB2-20P F G32

Part no.:10.01.38.00490

<https://www.schmalz.com/10.01.38.00490>



VSL 42-32 PU-DS

Part no.10.07.09.00036

Hose for vacuum and compressed-air systems

External diameter D: 42 mm

Internal diameter d: 32 mm

Length (max): 10 m

Material: PU, with wire spiral

Installation radius (min): 95 mm

Pressure range (operating pressure):

-0.95 ... 3.20 bar

Ambient temperature: -20 ... 90 °C

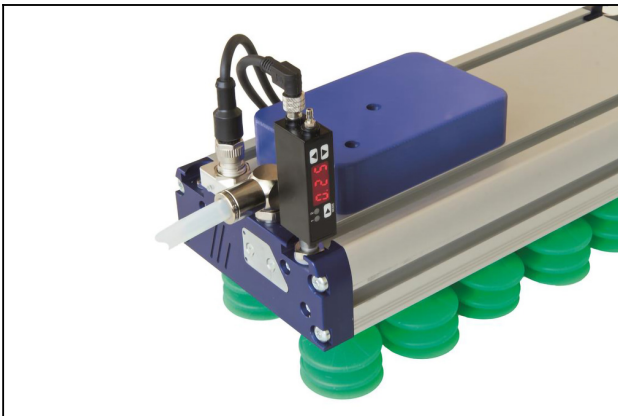

VS-MONT 50x15.8x25 VS

Part no.10.06.02.00343

Vacuum switch (inst)

Length L: 50 mm

Width B: 15.8 mm

Height H: 25 mm

for: Vacuum switch

SO: Standing mountable



VS-MONT 76.5x19 VSi FXP-FMP

Part no.10.01.38.02485

Vacuum switch (inst)

Length L: 76.5 mm

Width B: 19 mm

with: Vacuum and pressure switch

for: area gripper FXP-FMP

SO: Vertical mountable