

vacuum area gripper

FXP-S-SVK 442 5R36 SPB2-20P

Part no.:10.01.38.00958

<https://www.schmalz.com/10.01.38.00958>

Homepage > Vacuum Technology for Automation > Vacuum Components > Area Gripping Systems and End Effectors > Vacuum Area Gripping System FXP/FMP > Area Gripping Systems FXP > FXP-S-SVK 442 5R36 SPB2-20P

Vacuum area gripping system with integrated pneumatic vacuum ball check valves



Length L: 442 mm
 Width B: 130 mm
 Arrangement: 5 rows, 36mm
 Suct. cups: Bellows suct. cup SPB2
 Diameter Ds: 20 mm
 Shape: Push In
 with: Multi-stage ejector SEMP 50
 with: 1x Contr.-val. vacuum/blow off
 Interface Connection cable:
 Male connect M12, 4 pol
 Type: Switches to plus
 Voltage: 24V - DC
 Weight: 3.6 kg
 Air consumption: 250 l/min

Design Data

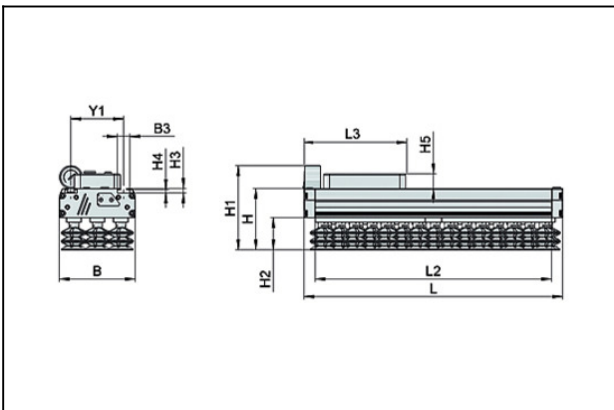

Attribute	Value
B	130 mm
B3	21.6 mm
Ds	20 mm
H	83 mm
H1	122 mm
H2	33 mm
H3	7.7 mm
H4	5.5 mm
H5	28 mm

Contact to Schmalz

J. Schmalz GmbH | Johannes-Schmalz-Straße, 72293 Glatten, Deutschland | +49 7443 2403-102 | customercenter@schmalz.de

vacuum area gripper

FXP-S-SVK 442 5R36 SPB2-20P

Part no.:10.01.38.00958

<https://www.schmalz.com/10.01.38.00958>



Attribute	Value
Y1	90 mm
L	442 mm
L2	402 mm
L3	154 mm
Valve type	SVK

Technical Data

Attribute	Value
Arrangement	5R36
Number of suction cells	55
Suction force	180 N
Suction rate (max.)	1,050 l/min
Air consumption	250.0
Sealing element	Suction Cups
Add. function	1x Contr.-val. vacuum/blow off
Weight	3.6 kg

Sound level: 74 dB(A) Max. degree of evacuation 55%

Spare Parts

Contact to Schmalz

J. Schmalz GmbH | Johannes-Schmalz-Straße, 72293 Glatten, Deutschland | +49 7443 2403-102 | customercenter@schmalz.de

vacuum area gripper

FXP-S-SVK 442 5R36 SPB2-20P

Part no.:10.01.38.00958

<https://www.schmalz.com/10.01.38.00958>



SPB2 20 SI-40 P

Part no.10.01.06.03125

Bellows suction cup (round) with 2.5 corr. for dynamic handling of cardboard and rigid packaging

Size: 20

Suction cup material: Silicone SI

Material hardness: 40 °Sh

Number of folds: 2.5

Shape: Push In

Accessories



ASK B-M12-5 5000 K-5P

Part no.21.04.05.00080

Connection cable

Interface Connection 1:

Fem connect M12, 5 pol

Cable length: 5000 mm

Interface Connection 2: Cable 5

Material: PUR-Cable

Shape: Straight



ASK WB-M8-4 5000 K-4P

Part no.10.06.02.00032

Connection cable

Interface Connection 1:

Elbow fem con M8, 4 pol

Cable length: 5000 mm

Interface Connection 2: Cable 4

Material: PUR-Cable

vacuum area gripper

FXP-S-SVK 442 5R36 SPB2-20P

Part no.:10.01.38.00958

<https://www.schmalz.com/10.01.38.00958>

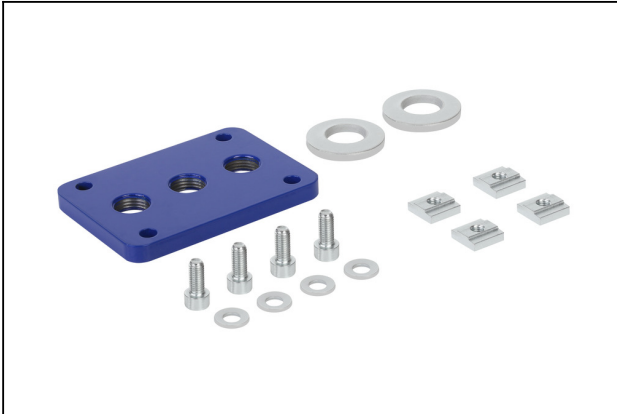

FLAN-PL 120x85x10 ST FLGR

Part no.10.01.10.05701

Flange plate

Length L: 120 mm

Width B: 85 mm

Height H: 10 mm

Material: Steel

for: Large-area vacuum gripper



FLK G1/2-IG G1/2-AG

Part no.10.01.03.00175

Flexible suction cup mounting for adaptation to sloping surfaces

Thread G1: G1/2"-F

Thread G2: G1/2"-M

Ambient temperature: 0 ... 70 °C



FST-FLEX 25 HD1 G1/2-AG G3/8-IG

Part no.10.01.10.05697

Spring plunger with both-way damping and height compensation, heavy-duty

Spring stroke Z: 25 mm

Shape: Heavy Duty 1 sp. plug

for: Mounting section

vacuum area gripper

FXP-S-SVK 442 5R36 SPB2-20P

Part no.:10.01.38.00958

<https://www.schmalz.com/10.01.38.00958>



FST-FLEX 25 HD2 G1/2-AG G3/8-IG

Part no.10.01.10.05695

Spring plunger with both-way damping and height compensation, heavy-duty

Spring stroke Z: 25 mm

Shape: Heavy Duty 2 sp. plug
for: Mounting section



FST-FLEX 50 HD1 G1/2-AG G3/8-IG

Part no.10.01.10.05687

Spring plunger with both-way damping and height compensation, heavy-duty

Spring stroke Z: 50 mm

Shape: Heavy Duty 1 sp. plug
for: Mounting section



FST-FLEX 50 HD2 G1/2-AG G3/8-IG

Part no.10.01.10.05168

Spring plunger with both-way damping and height compensation, heavy-duty

Spring stroke Z: 50 mm

Shape: Heavy Duty 2 sp. plug
for: Mounting section

vacuum area gripper

FXP-S-SVK 442 5R36 SPB2-20P

Part no.:10.01.38.00958

<https://www.schmalz.com/10.01.38.00958>



FST-FLEX 75 HD1 G1/2-AG G3/8-IG

Part no.10.01.10.05698

Spring plunger with both-way damping and height compensation, heavy-duty

Spring stroke Z: 75 mm

Shape: Heavy Duty 1 sp. plug
for: Mounting section



FST-FLEX 75 HD2 G1/2-AG G3/8-IG

Part no.10.01.10.05696

Spring plunger with both-way damping and height compensation, heavy-duty

Spring stroke Z: 75 mm

Shape: Heavy Duty 2 sp. plug
for: Mounting section



FST-STARR 25 HD1 G1/2-AG G3/8-IG

Part no.10.01.10.05810

Spring plunger with both-way damping and height compensation, heavy-duty

Spring stroke Z: 25 mm

Shape: Heavy Duty 1 spr. plunger
for: Mounting section

vacuum area gripper

FXP-S-SVK 442 5R36 SPB2-20P

Part no.:10.01.38.00958

<https://www.schmalz.com/10.01.38.00958>

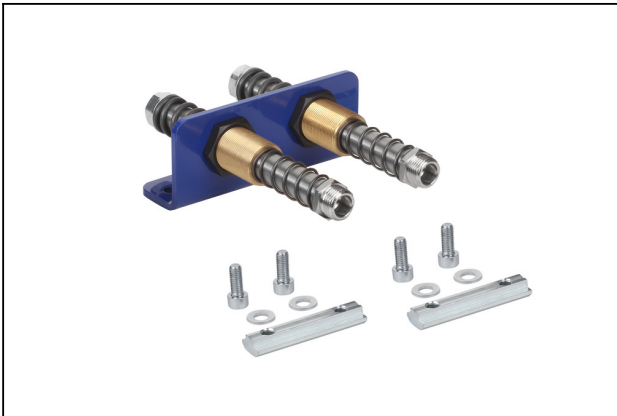

FST-STARR 25 HD2 G1/2-AG G3/8-IG

Part no.10.01.10.05806

Spring plunger with both-way damping and height compensation, heavy-duty

Spring stroke Z: 25 mm

Shape: Heavy Duty 2 spr. plunger
for: Mounting section



FST-STARR 50 HD1 G1/2-AG G3/8-IG

Part no.10.01.10.05809

Spring plunger with both-way damping and height compensation, heavy-duty

Spring stroke Z: 50 mm

Shape: Heavy Duty 1 spr. plunger
for: Mounting section



FST-STARR 50 HD2 G1/2-AG G3/8-IG

Part no.10.01.10.05805

Spring plunger with both-way damping and height compensation, heavy-duty

Spring stroke Z: 50 mm

Shape: Heavy Duty 2 spr. plunger
for: Mounting section

vacuum area gripper

FXP-S-SVK 442 5R36 SPB2-20P

Part no.:10.01.38.00958

<https://www.schmalz.com/10.01.38.00958>



FST-STARR 75 HD1 G1/2-AG G3/8-IG

Part no.10.01.10.05808

Spring plunger with both-way damping and height compensation, heavy-duty

Spring stroke Z: 75 mm

Shape: Heavy Duty 1 spr. plunger
for: Mounting section

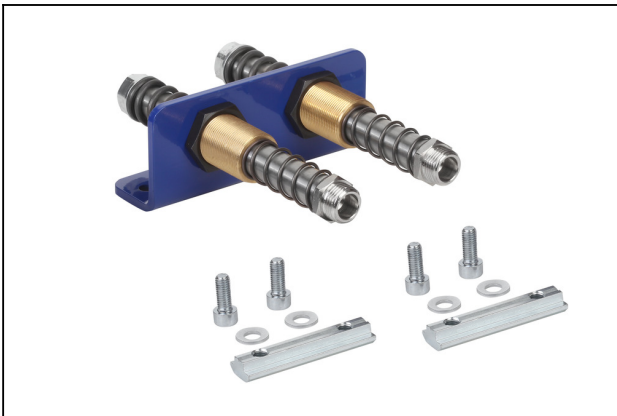

FST-STARR 75 HD2 G1/2-AG G3/8-IG

Part no.10.01.10.05803

Spring plunger with both-way damping and height compensation, heavy-duty

Spring stroke Z: 75 mm

Shape: Heavy Duty 2 spr. plunger
for: Mounting section

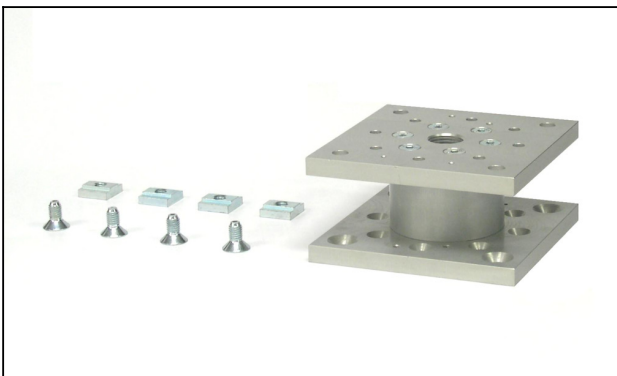

MOD-FLAN 120x120x60 FXP-FMP

Part no.10.01.21.00244

Flange module

Length L: 120 mm

Width B: 120 mm

Height H: 60 mm

for: Large-area vac grip FXP-FMP

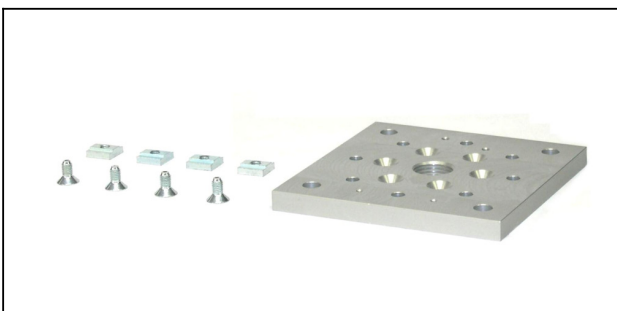

SET FXC-FMC

Part no.10.01.21.01291

Mounting set

for: Large-area vac grip FXC-FMC

vacuum area gripper

FXP-S-SVK 442 5R36 SPB2-20P

Part no.:10.01.38.00958

<https://www.schmalz.com/10.01.38.00958>



SET FXP-FMP

Part no.10.01.21.02407

Mounting set

for: Large-area vac grip FXP-FMP

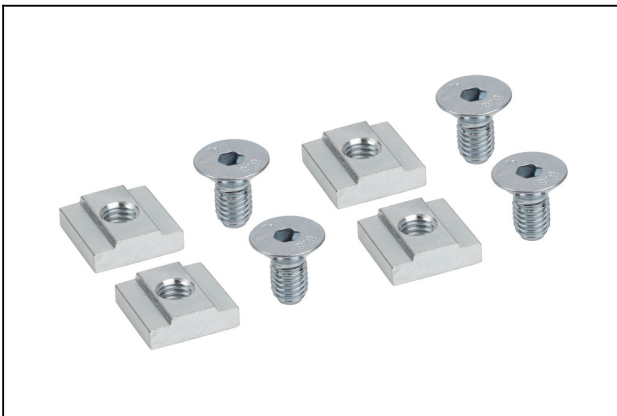

SET FXP-FMP 4xNUT-STEI

Part no.10.01.21.00243

Mounting set

for: area gripper FXP-FMP

Size: 4xNUT-STEI

Connection 1: M8



VAM 40 V U

Part no.10.07.02.00046

Vacuum gauge (manometer) for analogue measurement and monitoring of the vacuum

External diameter D: 40 mm

Measuring range: -1.00 ... 0.00 bar

Shape: Connection at bottom

Vacuum connection: G1/8"-M

vacuum area gripper

FXP-S-SVK 442 5R36 SPB2-20P

Part no.:10.01.38.00958

<https://www.schmalz.com/10.01.38.00958>



VSL 12-9 PU

Part no.10.07.09.00037

Hose for vacuum and compressed-air systems

External diameter D: 12 mm

Internal diameter d: 9 mm

Length (max): 50 m

Material: PU

Installation radius (min): 70 mm

Pressure range (operating pressure):

-0.95 ... 10.00 bar

Ambient temperature: -20 ... 90 °C

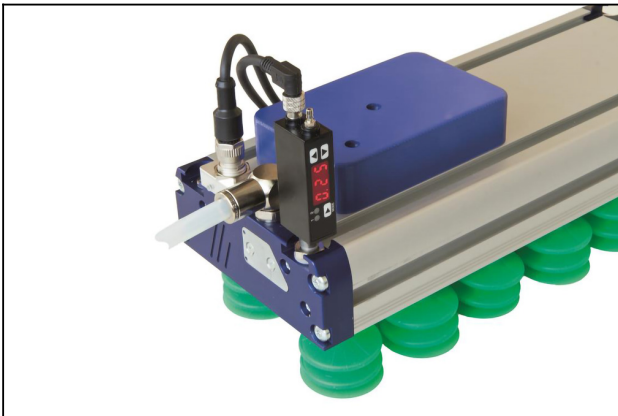

VS-MONT 50x15.8x25 VS

Part no.10.06.02.00343

Vacuum switch (inst)

Length L: 50 mm

Width B: 15.8 mm

Height H: 25 mm

for: Vacuum switch

SO: Standing mountable



VS-MONT 73x25x34.5 VS

Part no.10.01.10.00431

Vacuum switch (inst)

Length L: 73 mm

Width B: 25 mm

Height H: 34.5 mm

for: Vacuum switch

SO: With bracket (lying)

vacuum area gripper FXP-S-SVK 442 5R36 SPB2-20P

Part no.:10.01.38.00958

<https://www.schmalz.com/10.01.38.00958>



VS-MONT 76.5x19 VSi FXP-FMP

Part no.10.01.38.02485

Vacuum switch (inst)

Length L: 76.5 mm

Width B: 19 mm

with: Vacuum and pressure switch

for: area gripper FXP-FMP

SO: Vertical mountable