

vacuum area gripper

FXP-S-SVK 838 5R18 O10010

Part no.:10.01.38.00920

<https://www.schmalz.com/10.01.38.00920>

Homepage > Vacuum Technology for Automation > Vacuum Components > Area Gripping Systems and End Effectors > Vacuum Area Gripping System FXP/FMP > Area Gripping Systems FXP > FXP-S-SVK 838 5R18 O10010

Vacuum area gripping system with integrated pneumatic vacuum ball check valves



Length L: 838 mm
 Width B: 130 mm
 Arrangement: 5 rows, 18mm
 Material-Type: Foam O, Height 2x10 mm
 Flat recess: slot
 with: Multi-stage ejector SEMP 100
 with: 1x Contr.-val. vacuum/blow off
 Interface Connection 1:
 Male connect M12, 4 pol
 Type: Switches to plus
 Voltage: 24V - DC
 Weight: 4.4 kg
 Air consumption: 500 l/min

Design Data

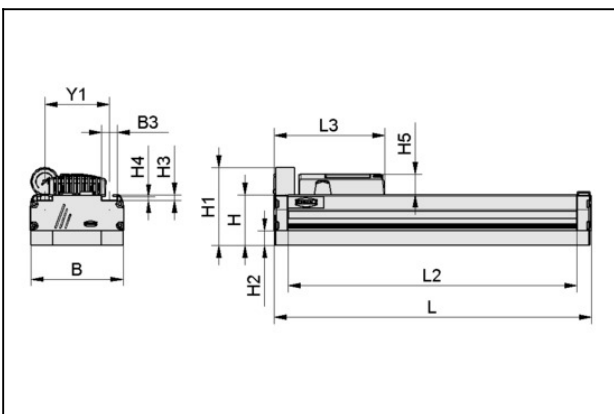

Attribute	Value
B	130 mm
B3	21.6 mm
H	70 mm
H1	109 mm
H2	20 mm
H3	7.7 mm
H4	5.5 mm
H5	28 mm
Y1	90 mm
L	838 mm

Contact to Schmalz

J. Schmalz GmbH | Johannes-Schmalz-Straße, 72293 Glatten, Deutschland | +49 7443 2403-102 | customercenter@schmalz.de

vacuum area gripper

FXP-S-SVK 838 5R18 O10O10

Part no.:10.01.38.00920

<https://www.schmalz.com/10.01.38.00920>



Attribute	Value
L2	798 mm
L3	154 mm
Valve type	SVK

Technical Data

Attribute	Value
Arrangement	5R18
Material type	Foam O, Height 2x10 mm
Number of suction cells	220
Suction force	840 N
Suction rate (max.)	1,600 l/min
Air consumption	500.0
Sealing element	Sealing Foam
Add. function	1x Contr.-val. vacuum/blow off
Weight	4.4 kg

Sound level: 74 dB(A) Max. degree of evacuation 55%

Accessories

Contact to Schmalz

J. Schmalz GmbH | Johannes-Schmalz-Straße, 72293 Glatten, Deutschland | +49 7443 2403-102 | customercenter@schmalz.de

vacuum area gripper

FXP-S-SVK 838 5R18 O10010

Part no.:10.01.38.00920

<https://www.schmalz.com/10.01.38.00920>



ASK B-M12-5 5000 K-5P

Part no.21.04.05.00080

Connection cable

Interface Connection 1:

Fem connect M12, 5 pol

Cable length: 5000 mm

Interface Connection 2: Cable 5

Material: PUR-Cable

Shape: Straight



ASK WB-M8-4 5000 K-4P

Part no.10.06.02.00032

Connection cable

Interface Connection 1:

Elbow fem con M8, 4 pol

Cable length: 5000 mm

Interface Connection 2: Cable 4

Material: PUR-Cable

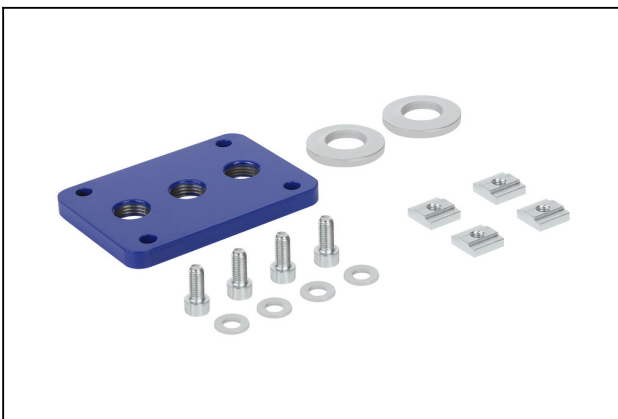

FLAN-PL 120x85x10 ST FLGR

Part no.10.01.10.05701

Flange plate

Length L: 120 mm

Width B: 85 mm

Height H: 10 mm

Material: Steel

for: Large-area vacuum gripper

vacuum area gripper

FXP-S-SVK 838 5R18 O10O10

Part no.:10.01.38.00920

<https://www.schmalz.com/10.01.38.00920>



FLK G1/2-IG G1/2-AG

Part no.10.01.03.00175

Flexible suction cup mounting for adaptation to sloping surfaces

Thread G1: G1/2"-F

Thread G2: G1/2"-M

Ambient temperature: 0 ... 70 °C

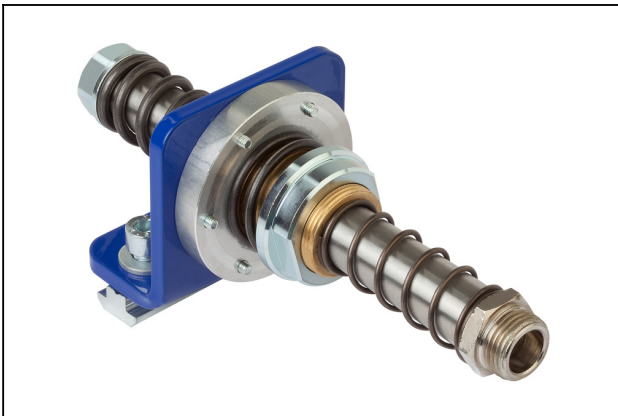

FST-FLEX 25 HD1 G1/2-AG G3/8-IG

Part no.10.01.10.05697

Spring plunger with both-way damping and height compensation, heavy-duty

Spring stroke Z: 25 mm

Shape: Heavy Duty 1 sp. plug
for: Mounting section



FST-FLEX 25 HD2 G1/2-AG G3/8-IG

Part no.10.01.10.05695

Spring plunger with both-way damping and height compensation, heavy-duty

Spring stroke Z: 25 mm

Shape: Heavy Duty 2 sp. plug
for: Mounting section

vacuum area gripper FXP-S-SVK 838 5R18 O10010

Part no.:10.01.38.00920

<https://www.schmalz.com/10.01.38.00920>



FST-FLEX 50 HD1 G1/2-AG G3/8-IG

Part no.10.01.10.05687

Spring plunger with both-way damping and height compensation, heavy-duty

Spring stroke Z: 50 mm

Shape: Heavy Duty 1 sp. plug
for: Mounting section



FST-FLEX 50 HD2 G1/2-AG G3/8-IG

Part no.10.01.10.05168

Spring plunger with both-way damping and height compensation, heavy-duty

Spring stroke Z: 50 mm

Shape: Heavy Duty 2 sp. plug
for: Mounting section



FST-FLEX 75 HD1 G1/2-AG G3/8-IG

Part no.10.01.10.05698

Spring plunger with both-way damping and height compensation, heavy-duty

Spring stroke Z: 75 mm

Shape: Heavy Duty 1 sp. plug
for: Mounting section

vacuum area gripper FXP-S-SVK 838 5R18 O10010

Part no.:10.01.38.00920

<https://www.schmalz.com/10.01.38.00920>



FST-FLEX 75 HD2 G1/2-AG G3/8-IG

Part no.10.01.10.05696

Spring plunger with both-way damping and height compensation, heavy-duty

Spring stroke Z: 75 mm

Shape: Heavy Duty 2 sp. plug
for: Mounting section



FST-STARR 25 HD1 G1/2-AG G3/8-IG

Part no.10.01.10.05810

Spring plunger with both-way damping and height compensation, heavy-duty

Spring stroke Z: 25 mm

Shape: Heavy Duty 1 spr. plunger
for: Mounting section



FST-STARR 25 HD2 G1/2-AG G3/8-IG

Part no.10.01.10.05806

Spring plunger with both-way damping and height compensation, heavy-duty

Spring stroke Z: 25 mm

Shape: Heavy Duty 2 spr. plunger
for: Mounting section

vacuum area gripper

FXP-S-SVK 838 5R18 O10010

Part no.:10.01.38.00920

<https://www.schmalz.com/10.01.38.00920>



FST-STARR 50 HD1 G1/2-AG G3/8-IG

Part no.10.01.10.05809

Spring plunger with both-way damping and height compensation, heavy-duty

Spring stroke Z: 50 mm

Shape: Heavy Duty 1 spr. plunger
for: Mounting section



FST-STARR 50 HD2 G1/2-AG G3/8-IG

Part no.10.01.10.05805

Spring plunger with both-way damping and height compensation, heavy-duty

Spring stroke Z: 50 mm

Shape: Heavy Duty 2 spr. plunger
for: Mounting section



FST-STARR 75 HD1 G1/2-AG G3/8-IG

Part no.10.01.10.05808

Spring plunger with both-way damping and height compensation, heavy-duty

Spring stroke Z: 75 mm

Shape: Heavy Duty 1 spr. plunger
for: Mounting section

vacuum area gripper

FXP-S-SVK 838 5R18 O10010

Part no.:10.01.38.00920

<https://www.schmalz.com/10.01.38.00920>



FST-STARR 75 HD2 G1/2-AG G3/8-IG

Part no.10.01.10.05803

Spring plunger with both-way damping and height compensation, heavy-duty

Spring stroke Z: 75 mm

Shape: Heavy Duty 2 spr. plunger
for: Mounting section

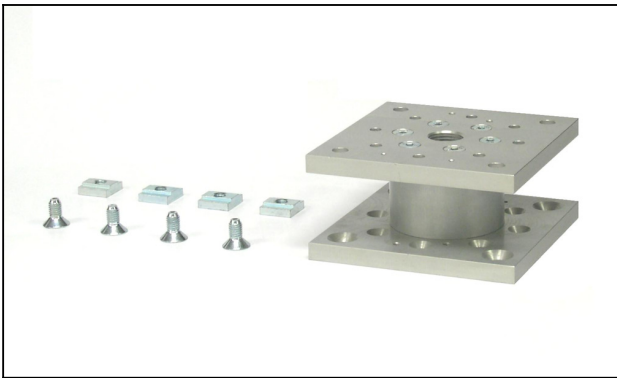

MOD-FLAN 120x120x60 FXP-FMP

Part no.10.01.21.00244

Flange module

Length L: 120 mm

Width B: 120 mm

Height H: 60 mm

for: Large-area vac grip FXP-FMP

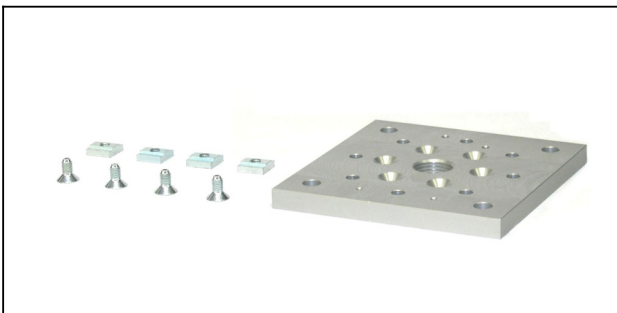

SET FXC-FMC

Part no.10.01.21.01291

Mounting set

for: Large-area vac grip FXC-FMC

vacuum area gripper

FXP-S-SVK 838 5R18 O10O10

Part no.:10.01.38.00920

<https://www.schmalz.com/10.01.38.00920>

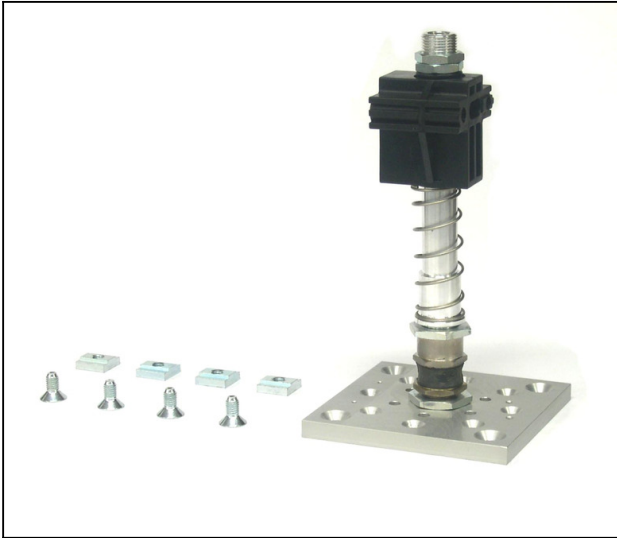

SET FXP-FMP

Part no.10.01.21.02407

Mounting set

for: Large-area vac grip FXP-FMP

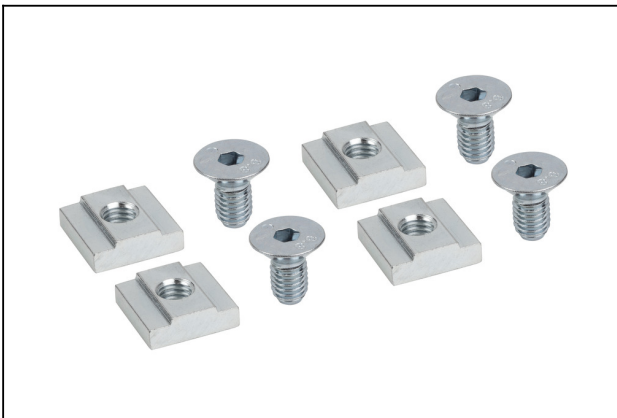

SET FXP-FMP 4xNUT-STEI

Part no.10.01.21.00243

Mounting set

for: area gripper FXP-FMP

Size: 4xNUT-STEI

Connection 1: M8



VAM 40 V U

Part no.10.07.02.00046

Vacuum gauge (manometer) for analogue measurement and monitoring of the vacuum

External diameter D: 40 mm

Measuring range: -1.00 ... 0.00 bar

Shape: Connection at bottom

Vacuum connection: G1/8"-M

vacuum area gripper

FXP-S-SVK 838 5R18 O10O10

Part no.:10.01.38.00920

<https://www.schmalz.com/10.01.38.00920>



VSL 12-9 PU

Part no.10.07.09.00037

Hose for vacuum and compressed-air systems

External diameter D: 12 mm

Internal diameter d: 9 mm

Length (max): 50 m

Material: PU

Installation radius (min): 70 mm

Pressure range (operating pressure):

-0.95 ... 10.00 bar

Ambient temperature: -20 ... 90 °C

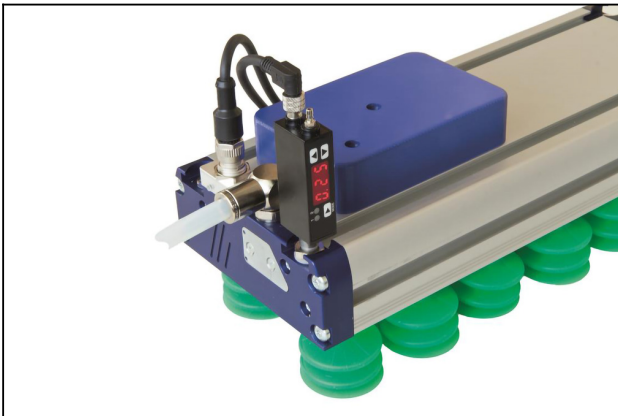

VS-MONT 50x15.8x25 VS

Part no.10.06.02.00343

Vacuum switch (inst)

Length L: 50 mm

Width B: 15.8 mm

Height H: 25 mm

for: Vacuum switch

SO: Standing mountable



VS-MONT 73x25x34.5 VS

Part no.10.01.10.00431

Vacuum switch (inst)

Length L: 73 mm

Width B: 25 mm

Height H: 34.5 mm

for: Vacuum switch

SO: With bracket (lying)

vacuum area gripper FXP-S-SVK 838 5R18 O10010

Part no.:10.01.38.00920

<https://www.schmalz.com/10.01.38.00920>



VS-MONT 76.5x19 VSi FXP-FMP

Part no.10.01.38.02485

Vacuum switch (inst)

Length L: 76.5 mm

Width B: 19 mm

with: Vacuum and pressure switch

for: area gripper FXP-FMP

SO: Vertical mountable