

Profile

- Compact design
- Universally applicable thanks to standardized interfaces
- Easy mounting
- Measurement lengths up to max. 2000 mm
- Potentiometer, voltage, power output or incremental encoder
- Housing made of reinforced plastic

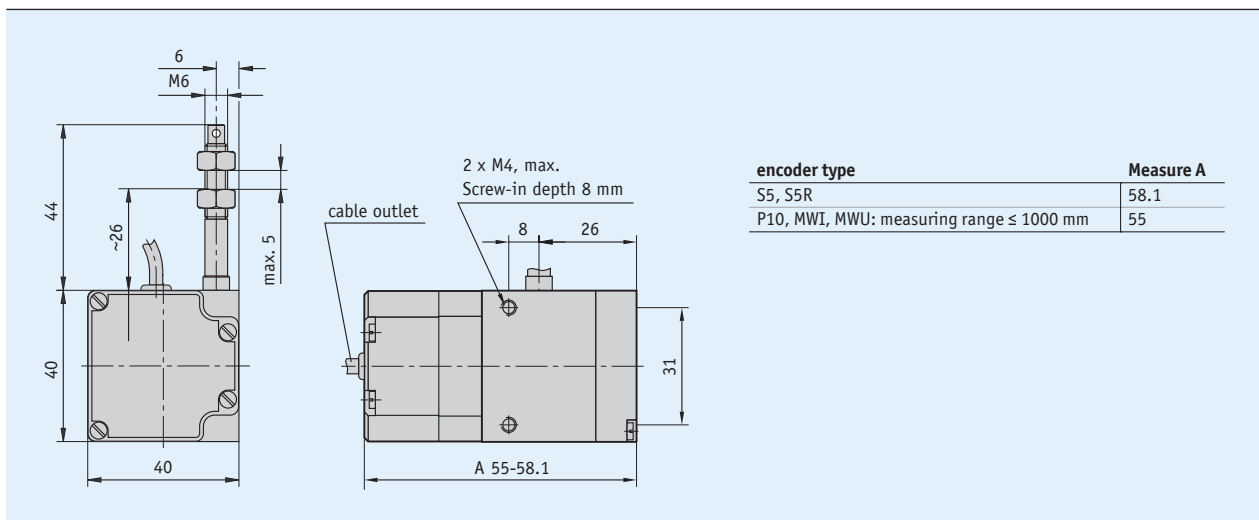
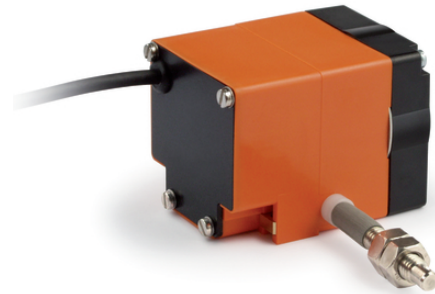

Mechanical data

Feature	Technical data	Additional information
Housing	reinforced plastic	
Wire design	steel wire (stainless steel) $\varnothing 0.45$ mm	plastic coated
Extension force	≥ 2 N	
Measured distance/ rope drum revolution	100 mm	
Cable length	≤ 30 m	P10 + MWI encoder type
	≤ 20 m	MWU encoder type
Weight	~ 0.2 kg	

Electrical data

Encoder potentiometer

Feature	Technical data	Additional information
Power rating	1.5 W at 70 °C	
Resistance	10 k Ω	
Resistance tolerance	± 5 %	
Linearity tolerance	± 0.25 %	
	± 0.1 %	encoder type MWI/0,1

Transducer, power output

Feature	Technical data	Additional information
Operating voltage	24 V DC ± 20 %	at $\leq 500 \Omega$ load
Output current	4 ... 20 mA	

■ Transducer, voltage output

Feature	Technical data	Additional information
Operating voltage	15 ... 28 V DC	at 3 mA, no load
Output voltage	0 ... 10 V DC	
Load	≤15 mA	

* Measurement transducers permit optimum adjustment of the output current and output voltage to the measuring range. The measurement transducer is pre-set at the works so that an output signal of 4 ... 20 mA (MWI) or 0 ... 10 V DC (MWU) is available.

System data

Feature	Technical data	Additional information
Repeat accuracy	±0.15 mm	
Travel speed	≤800 mm/s	

Ambient conditions

Feature	Technical data	Additional information
Ambient temperature	-10 ... 80 °C	without transducer
	0 ... 50 °C	with transducer
Protection category	IP50 (encoder part potentiometer)	EN 600529
	IP54 (incremental)	EN 600529

Pin assignment

■ Potentiometric outputs P10

Signal	E1 (terminal)
Po	brown
Pe	white
S	green

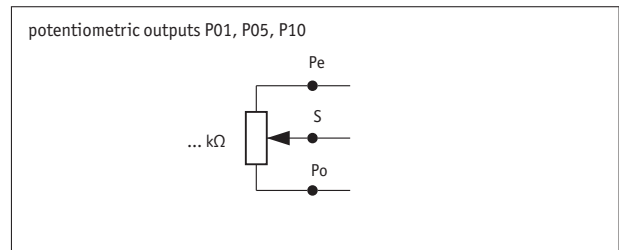

■ MWI transducer

Signal	Cable color
I+	brown
I-	white

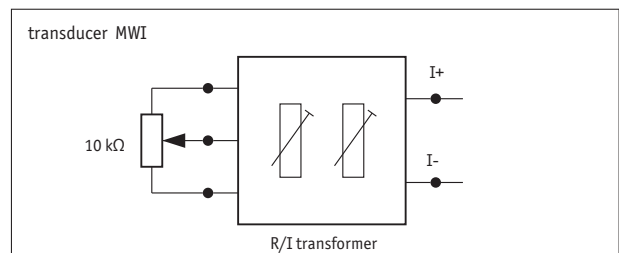

■ MWU transducer

Signal	Cable color
+24 V DC	brown
GND	white
U _{out}	green

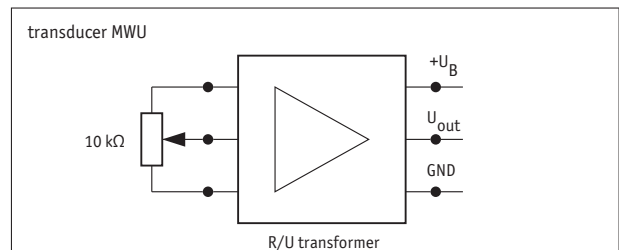

Hint for mounting

When securing the wire it must be ensured that the wire is straight and vertical in relation to the wire outlet.
 Recommendation: Only select the starting position after an unwound length of approx. 5 mm. This prevents the wire hitting the end stop when it is rewound.

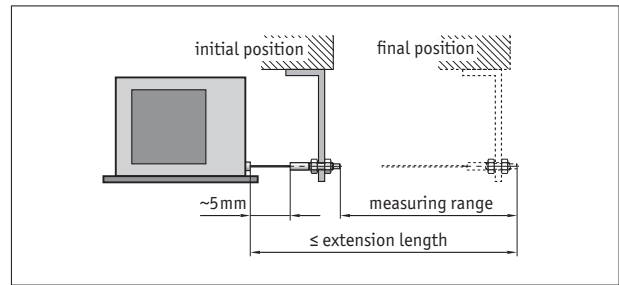

symbolic depiction

Order

Ordering information

For measuring range 2000 I, the rotary encoder IV2800 mounted directly from the factory must be ordered separately.

Ordering table

Feature	Ordering data	Specification	Additional information
Measuring range	... 2000I A	300, 500, 1000 in mm	encoder types Ω, I, U (potentiometer and transducer) only with encoder type S5, S5R
Encoder type	P10 B MWI MWU S5 S5R	potentiometer with 10kΩ transducer 4 ... 20 mA transducer 0 ... 10 V rotary encoder IV2800, axial cable outlet rotary encoder IV2800, radial cable outlet others on request	
Cable length	0.5 C ... IG	0.5 m 1 ... 20 m, in steps of 1 m specified via mounted encoder	with encoder type P10 or MWI/MWU with encoder type P10 or MWI/MWU at measuring range 2000 I

Order key

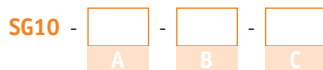

Scope of delivery: SG10

Accessories:
 Electronic display MA50
 Guide roller UR

www.siko-global.com
www.siko-global.com